

Register your product and get support at

[www.philips.com/welcome](http://www.philips.com/welcome)

32PFL3605/12

42PFL3605/12



---

EN User Manual

**PHILIPS**



Österreich	0800 180 016	
België/Belgique	80080190	
България	00800 11 544 24	
Hrvatska	01 6403 776	Lokalni poziv
Česká republika	800142840	Bezplatný hovor
Danmark	3525 8759	Lokalt opkald
Estonia	6008600	kohalik kõne tariifi
Suomi	09 2311 3415	paikallispuhelu
France	0805 025 510	numéro sans frais
Deutschland	0800 000 7520	gebührenfreier Anruf
Ελλάδα	0 0800 3122 1280	Κλήση χωρίς χρέωση
Magyarország	0680018189	Ingyenes hívás
Hrvatska	0800 222778	free
Ireland	01 601 1777	
Italia	800 088774	Numero Verde
Қазақстан	+7 727 250 66 17	local
Latvia	52737691	local
Lithuania	67228896	local
Luxemburg/Luxembourg	40 6661 5644	Ortsgespräch/Appel local
Nederland	0800 0230076	Gratis nummer
Norge	22 70 81 11	Lokalsamtale
Polska	00800-311-13-18	Pozosta?e produkty RTV oraz AGD
Portugal	800 780 903	Chamada Grátis
România	0800-894910 0318107125	Apel gratuit Apel local
Россия	(495) 961-1111	0.15 USD/minute
Србија	+381 114 440 841	Lokalni poziv
Slovensko	0800 004537	Bezplatný hovor
Slovenija	00386 12 80 95 00	lokalni klic
España	900 800 655	Teléfono local gratuito solamente para clientes en España
Sverige	08 5792 9100	Lokalsamtal
Suisse/Schweiz/Svizzera	0800 002 050	Schweizer Festnetztarif/ Tarif réseau fixe France
Türkiye	0800 261 3302	Şehiriçi arama
United Kingdom	General No: 0800 331 6015 General National Rate No: 0870 911 0036	free National rate
Україна	0-800-500-697	

# Contents

---

<b>1 Notice</b>	2
-----------------	---

---

<b>2 Important</b>	4
--------------------	---

---

<b>3 Your TV</b>	7
Side controls and indicators	7
Remote control	7

---

<b>4 Use your TV</b>	9
Switch your TV on / off or to standby	9
Switch channels	9
Watch connected devices	10
Adjust TV volume	10
Use teletext	10

---

<b>5 Use more of your TV</b>	11
Access TV menus	11
Rename devices from the home menu	11
Remove devices from the home menu	11
Change picture and sound settings	12
Use advanced teletext features	14
Create and use list of favourite channels	15
Use the TV clock	16
Use timers	16
Use TV locks	17
View photos and play music from a USB storage device	18
Update the TV software	20
Change TV preferences	20
Access decoder channel	21
Start a TV demo	21
Reset the TV to factory settings	21

---

<b>6 Install channels</b>	22
Automatically install channels	22
Manually install channels	22
Rename channels	24
Rearrange channels	24

---

<b>7 Connect devices</b>	25
Back connector	25
Side connector	27
Connect a computer	28
Use Philips EasyLink	29
Use a Kensington lock	30

---

<b>8 Product information</b>	31
Supported display resolutions	31
Multimedia	31
Tuner / Reception / Transmission	31
Remote control	31
Power	31
Supported TV mounts	31
Product specification	32

---

<b>9 Troubleshooting</b>	33
General TV issues	33
TV channel issues	33
Picture issues	34
Sound issues	34
HDMI connection issues	34
Computer connection issues	35
Contact us	35

---

<b>10 Index</b>	36
-----------------	----

# 1 Notice

2010 © Koninklijke Philips Electronics N.V. All rights reserved.

Specifications are subject to change without notice. Trademarks are the property of Koninklijke Philips Electronics N.V or their respective owners. Philips reserves the right to change products at any time without being obliged to adjust earlier supplies accordingly. The material in this manual is believed adequate for the intended use of the system. If the product, or its individual modules or procedures, are used for purposes other than those specified herein, confirmation of their validity and suitability must be obtained. Philips warrants that the material itself does not infringe any United States patents. No further warranty is expressed or implied.

## Warranty

- Risk of injury, damage to TV or void of warranty! Never attempt to repair the TV yourself.
- Use the TV and accessories only as intended by the manufacturer.
- The caution sign printed on the back of the TV indicates risk of electric shock. Never remove the TV cover. Always contact Philips Customer Support for service or repairs.



- Any operation expressly prohibited in this manual, or any adjustments and assembly procedures not recommended or authorised in this manual shall void the warranty.

## Pixel characteristics

This LCD product has a high number of colour pixels. Although it has effective pixels of 99.999% or more, black dots or bright points of light (red, green or blue) may appear constantly on the screen. This is a structural property of the display (within common industry standards) and is not a malfunction.

## Compliance with EMF

Koninklijke Philips Electronics N.V. manufactures and sells many products targeted at consumers which, like any electronic apparatus, in general have the ability to emit and receive electromagnetic signals.

One of Philips' leading Business Principles is to take all necessary health and safety measures for our products, to comply with all applicable legal requirements and to stay well within the EMF standards applicable at the time of producing the products.

Philips is committed to develop, produce and market products that cause no adverse health effects. Philips confirms that if its products are handled properly for their intended use, they are safe to use according to scientific evidence available today.

Philips plays an active role in the development of international EMF and safety standards, enabling Philips to anticipate further developments in standardisation for early integration in its products.

## Mains fuse (UK only)

This TV is fitted with an approved moulded plug. Should it become necessary to replace the mains fuse, this must be replaced with a fuse of the same value as indicated on the plug (example 10A).

- 1 Remove fuse cover and fuse.
- 2 The replacement fuse must comply with BS 1362 and have the ASTA approval mark. If the fuse is lost, contact your dealer in order to verify the correct type.
- 3 Refit the fuse cover.

In order to maintain conformity to the EMC directive, the mains plug on this product must not be detached from the mains cord cable.

## Copyright

® Kensington and Micro Saver are registered US trademarks of ACCO World corporation with issued registrations and pending applications in other countries throughout the world.



HDMI, the HDMI logo and High-Definition Multimedia Interface are trademarks or registered trademarks of HDMI Licensing LLC. All other registered and unregistered trademarks are the property of their respective owners.

## 2 Important

Read and understand all instructions before you use your TV. If damage is caused by failure to follow instructions, the warranty does not apply.

---

### Safety

#### Risk of electric shock or fire!

- Never expose the TV to rain or water. Never place liquid containers, such as vases, near the TV. If liquids are spilt on or into the TV, disconnect the TV from the power outlet immediately. Contact Philips Consumer Care to have the TV checked before use.
- Never place the TV, remote control or batteries near naked flames or other heat sources, including direct sunlight. To prevent the spread of fire, keep candles or other flames away from the TV, remote control and batteries at all times.



- Never insert objects into the ventilation slots or other openings on the TV.
- When the TV is swivelled ensure that no strain is exerted on the power cord. Strain on the power cord can loosen connections and cause arcing.

#### Risk of short circuit or fire!

- Never expose the remote control or batteries to rain, water or excessive heat.
- Avoid force coming onto power plugs. Loose power plugs can cause arcing or fire.

#### Risk of injury or damage to the TV!

- Two people are required to lift and carry a TV that weighs more than 25 kg.
- When stand mounting the TV, use only the supplied stand. Secure the stand to the TV tightly. Place the TV on a flat, level surface that can support the combined weight of the TV and the stand.
- When wall mounting the TV, use only a wall mount that can support the weight of the TV. Secure the wall mount to a wall that can support the combined weight of the TV and wall mount. Koninklijke Philips Electronics N.V. bears no responsibility for improper wall mounting that result in accident, injury or damage.

#### Risk of injury to children!

Follow these precautions to prevent the TV from toppling over and causing injury to children:

- Never place the TV on a surface covered by a cloth or other material that can be pulled away.
- Ensure that no part of the TV hangs over the edge of the surface.
- Never place the TV on tall furniture (such as a bookcase) without anchoring both the furniture and TV to the wall or a suitable support.
- Educate children about the dangers of climbing on furniture to reach the TV.

#### Risk of overheating!

- Never install the TV in a confined space. Always leave a space of at least 4 inches or 10 cm around the TV for ventilation. Ensure curtains or other objects never cover the ventilation slots on the TV.

#### Risk of damage to the TV!

- Before you connect the TV to the power outlet, ensure that the power voltage matches the value printed on the back of the TV. Never connect the TV to the power outlet if the voltage is different.

### Risk of injury, fire or power cord damage!

- Never place the TV or any objects on the power cord.
- To disconnect the TV power cord easily from the power outlet, ensure that you have full access to the power cord at all times.
- When you disconnect the power cord, always pull the plug, never the cable.
- Disconnect the TV from the power outlet and antenna before lightning storms. During lightning storms, never touch any part of the TV, power cord or antenna cable.

### Risk of hearing damage!

- Avoid using earphones or headphones at high volumes or for prolonged periods of time.

### Low temperatures

- If the TV is transported in temperatures below 5°C, unpack the TV and wait until the TV temperature matches room temperature before connecting the TV to the power outlet.

---

## Screen care

- Avoid stationary images as much as possible. Stationary images are images that remain on-screen for extended periods of time. Examples include: on-screen menus, black bars and time displays. If you must use stationary images, reduce screen contrast and brightness to avoid screen damage.
- Unplug the TV before cleaning.
- Clean the TV and frame with a soft, damp cloth. Never use substances such as alcohol, chemicals or household cleaners on the TV.
- Risk of damage to the TV screen! Never touch, push, rub or strike the screen with any object.
- To avoid deformations and colour fading, wipe off water drops as soon as possible.

---

## Disposal of your old product and batteries



Your product is designed and manufactured with high quality materials and components, which can be recycled and reused.



When this crossed-out wheeled bin symbol is attached to a product it means that the product is covered by the European Directive 2002/96/EC. Please inform yourself about the local separate collection system for electrical and electronic products.

Please act according to your local rules and do not dispose of your old products with your normal household waste.

Correct disposal of your old product helps to prevent potential negative consequences for the environment and human health.



Your product contains batteries covered by the European Directive 2006/66/EC, which cannot be disposed with normal household waste.

Please inform yourself about the local rules on separate collection of batteries because correct disposal helps to prevent negative consequences for the environmental and human health.

---

## Energy efficiency features

- **Ambient light sensor** (Available in selected models only)  
To save energy, the built-in Ambient light sensor lowers the brightness of the TV screen when the surrounding light darkens.
- **Energy saving**  
The energy saving setting of the TV combines several TV settings that result in saving energy. See the smart settings in the setup menu.
- **Low standby power consumption**  
The class-leading and highly advanced power circuitry brings down the power consumption of the TV to an extremely low level, without losing out on the constant standby functionality.

**Power management** (Available in selected models only)

The advanced power management of this TV ensures the most efficient use of its energy. You can check how your personal TV settings, the level of brightness in current onscreen pictures and the surrounding light conditions determine the relative power consumption.

### End of use

To inform yourself on the correct disposal of the TV and batteries, refer to 'Disposal of your old product and batteries' in the user manual (see 'Disposal of your old product and batteries' on page 5).



# 3 Your TV

Congratulations on your purchase, and welcome to Philips! To fully benefit from the support that Philips offers, register your TV at [www.philips.com/welcome](http://www.philips.com/welcome).

This section gives you an overview of commonly used TV controls and functions.

## Side controls and indicators

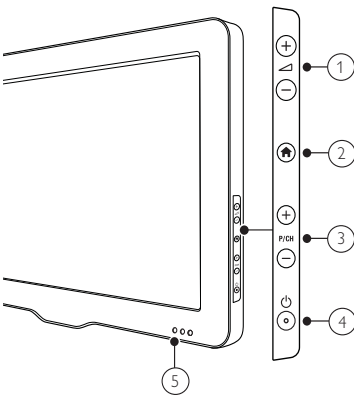

- ①  $\triangleleft$  +/-: Increases or decreases volume.
- ② 🏠 (Home): Toggles the home menu on or off.
- ③ P/CH +/-: Switches to the next or previous channel.
- ④ ⏻ (Power): Switches the product on or off. The product is not powered off completely unless it is physically unplugged.
- ⑤ Standby indicator and remote control sensor.

## Remote control

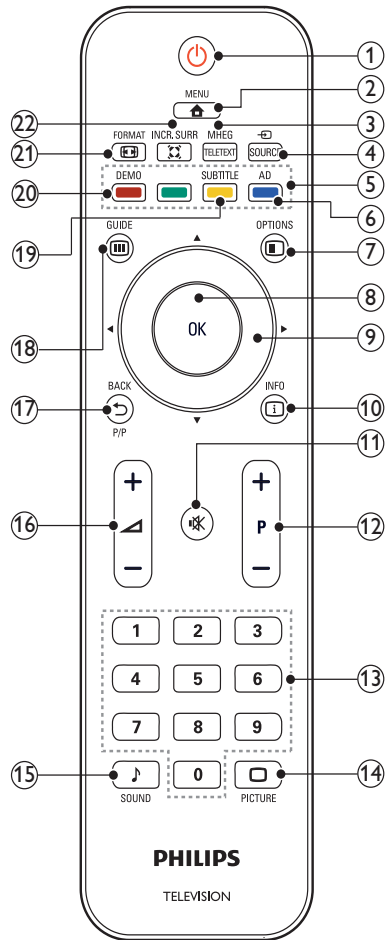

- ① **⏻ (Standby-On)**
  - Switches the TV to standby if it is on.
  - Switches on the TV if it is in standby.
- ② **☰ MENU**  
Toggles the main menu on or off.
- ③ **MHEG/TELETEXT**  
Toggles teletext on or off.
- ④ **📺 SOURCE**  
Selects connected devices.
- ⑤ **Colour buttons**  
Selects tasks or options.
- ⑥ **AD (Audio Descriptor) (For RF Digital TV only)**  
UK only: Enables audio commentary for the visually handicapped.
- ⑦ **☰ OPTIONS**  
Accesses options relating to the current activity or selection.
- ⑧ **OK**  
Confirms an entry or selection and displays the channel grid, when watching TV.
- ⑨ **⬆️⬅️➡️⬆️ (Navigation buttons)**  
Navigates menus.
- ⑩ **📄 INFO**  
Displays program information, when available. If the information spans multiple pages, press **OPTIONS** to go to the next page.
- ⑪ **🔇 (Mute)**  
Mutes or restores volume.
- ⑫ **P +/- (Programme +/-)**  
Switches to the next or previous channel. When the TV menu is on, this functions as Page Up / Down.
- ⑬ **0-9 (Numeric buttons)**  
Selects a channel or setting.
- ⑭ **🖼️ PICTURE (Smart picture)**  
Launches the picture menu.
- ⑮ **🔊 SOUND (Smart Sound)**  
Launches the sound menu.
- ⑯ **↔️ +/- (Volume +/-)**  
Increases or decreases volume.
- ⑰ **⏮️ BACK P/P (Previous channel)**
  - Returns to a previous screen.
  - Returns to the previously viewed channel.
- ⑱ **📺 GUIDE**  
Switches between channel grid and programme list.
- ⑲ **SUBTITLE (For RF Digital TV only)**  
Enables or disables subtitles.
- ⑳ **DEMO (Used in selected models only)**  
Toggles the demonstration menu on or off.
- ㉑ **🖼️ FORMAT**  
Selects a picture format.
- ㉒ **🔊 INCR. SURR**  
Enables Incredible Surround for stereo sources. Enables spatial mode for mono sources.

---

## Remote control usage

When using the remote control, hold it close to the TV and point it at the remote control sensor. Make sure that the line-of-sight between the remote control and TV is not blocked by furniture, walls or other objects.

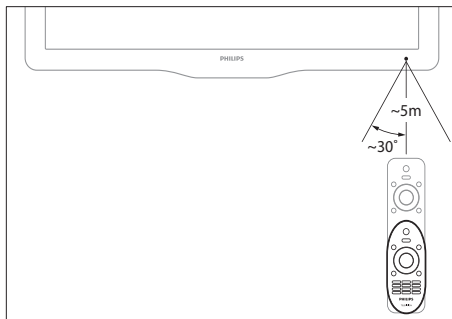

## 4 Use your TV

This section helps you perform basic TV operations.

### Switch your TV on / off or to standby

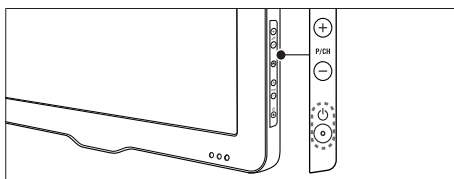

#### To switch on

- If the standby indicator is off, press **⏻ (Power)** at the side of the TV.
- If the standby indicator is red, press **⏻ (Standby-On)** on the remote control.

#### To switch to standby

- Press **⏻ (Standby-On)** on the remote control.
  - ↳ The standby indicator switches to red.

#### To switch off

- Press **⏻ (Power)** at the side of the TV.
  - ↳ The standby indicator switches off.



#### Tip

- Though your TV consumes very little power when in standby, energy continues to be consumed. When not in use for an extended period of time, disconnect the TV power cable from the power outlet.



#### Note

- If you cannot locate your remote control and want to switch on the TV from standby, press **P/CH +/-** on the side of the TV.

### Switch channels

- Press **P +/-** on the remote control or **P/CH +/-** on the side of the TV.
- Enter a channel number using the **Numeric buttons**.
- Press **OK** to use the channel grid.
- Press **↩ BACK P/P** on the remote control to return to the previous channel.



#### Note

- When you use a favourite list, you can only select those channels in the list (see 'Select a favourite list' on page 15).

### Switch channels with the channel grid

The channel grid allows you to view all available channels in a grid format.

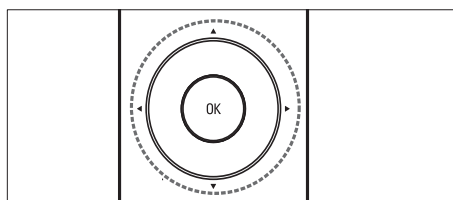

- 1 Press **OK**.
  - ↳ The channel grid appears.
- 2 Press **▲▼◀▶** to select and preview a channel.
- 3 Press **OK** to watch the selected channel.

## Watch connected devices

### Note

- Switch on the device before selecting it as a source on the TV.

## Use the source button

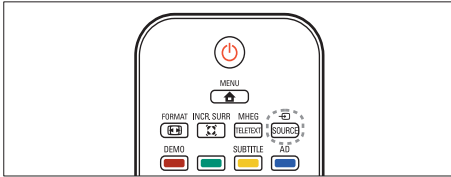

- 1 Press **SOURCE**.  
↳ The source list appears.
- 2 Press **▲▼** to select a device.
- 3 Press **OK** to confirm your choice.  
↳ The TV switches to the selected device.

## Use teletext

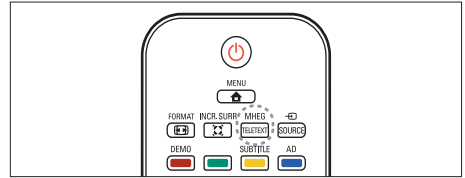

- 1 Press **MHEG/TELETEXT**.  
↳ The main index page appears.
- 2 Select a page as follows:
  - Press the **Numeric buttons** to enter a page number
  - Press **P +/-** to view the next or previous page
  - Press the **Colour buttons** to select a colour coded item
  - Press **BACK** to return to a previously viewed page
- 3 Press **MHEG/TELETEXT** to exit teletext.

## Adjust TV volume

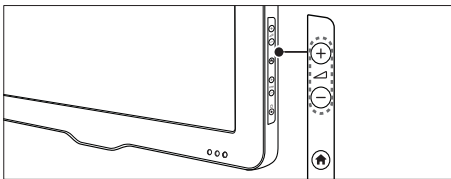
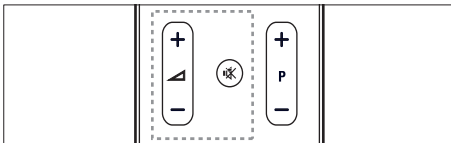

### To increase or decrease volume

- Press **▲ +/-**.

### To mute or unmute sound

- Press **🔇** to mute the sound.
- Press **🔇** again to restore the sound.

# 5 Use more of your TV

## Access TV menus

Menus help you to install channels, change picture and sound settings and access other features.

- 1 Press **MENU**.  
↳ The menu screen appears.

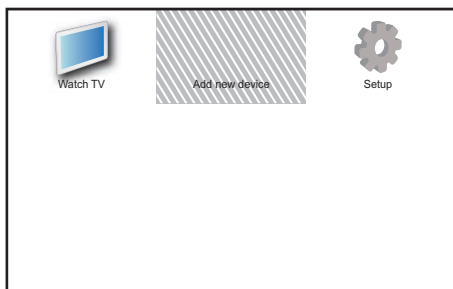

- 2 Press **▲▼◀▶** to select and navigate through one of the following menus.
  - **[Watch TV]**: Switches back to the aerial source if another source is selected.
  - **[Add new device]**: Adds new devices to the home menu.
  - **[Setup]**: Accesses menus to change picture, sound and other settings.
- 3 Press **OK** to confirm your choice.
- 4 Press **MENU** to exit.



Tip

- After selecting **[Add new device]**, follow the on-screen instructions to select the correct device and connector.

## Rename devices from the home menu

After adding a new device to the home menu, you can rename it to your preference.

- 1 Press **MENU**.
- 2 Press **▲▼◀▶** to select a device to rename.
- 3 Press **OPTIONS**.  
↳ The options menu appears.
- 4 Press **▲▼** to select **[Rename device]**, then press **OK**.  
↳ A text input box appears.
- 5 Press **▲▼◀▶** to select characters.
- 6 Press **OK** to confirm each character.
- 7 Select **[Done]**, then press **OK** to finish renaming devices.

### Note

- The device name can be up to six characters long.
- Press **[Aa]** to change an uppercase letter to a lowercase letter and vice versa.

## Remove devices from the home menu

If a device is no longer connected to the TV, remove it from the home menu.

- 1 Press **MENU**.
- 2 Press **▲▼◀▶** to select a device to remove.
- 3 Press **OPTIONS**.
- 4 Press **▲▼** to select **[Remove device]**, then press **OK**.
- 5 Select **[Remove]**, then press **OK**.  
↳ The selected device is removed from the home menu.

---

## Change picture and sound settings

Change picture and sound settings to suit your preferences. You can apply pre-defined settings or change settings manually.



### Note

- When watching TV or using external devices, press  **OPTIONS** then select **[Picture and sound]** for quick access to picture and sound settings.

---



## Use smart picture

Use smart picture to apply pre-defined picture settings.

- 1 Press  **PICTURE**.  
↳ The **[Smart picture]** menu appears.
- 2 Press  to select one of the following settings.
  - **[Vivid]**: Applies rich and dynamic settings.
  - **[Standard]**: Adjusts picture settings to suit most environments and types of video.
  - **[Cinema]**: Applies settings for movie viewing.
  - **[Game]**: Applies settings for games.
  - **[Energy saving]**: Applies low-energy settings.
  - **[Natural]**: Applies the best picture quality.
  - **[Custom]**: Lists customised picture settings.
- 3 Press **OK** to confirm your choice.  
↳ The selected smart picture setting is applied.

---

## Manually adjust picture settings

- 1 Press  **MENU**.
- 2 Press  to select **[Setup]** > **[Picture]**.
- 3 Press  to select the following settings.
  - **[Smart picture]**: Accesses pre-defined smart picture settings.
  - **[Video contrast]**: Adjusts the intensity of video contents, keeping backlight unchanged.
  - **[Contrast]**: Adjusts the intensity of backlight areas, keeping video contents unchanged.
  - **[Brightness]**: Adjusts the intensity and details of dark areas.
  - **[Colour]**: Adjusts colour saturation.
  - **[Hue]**: Compensates for colour variations.
  - **[Sharpness]**: Adjusts sharpness in the image.
  - **[Noise reduction]**: Filters and reduces noise in an image.
  - **[Tint]**: Adjusts the colour balance in an image.
  - **[Custom tint]**: Customises tint setting. (Only available if **[Tint]** > **[Custom]** is selected)
  - **[Dig. Crystal Clear]**: Fine-tunes each pixel to match surrounding pixels. This produces a brilliant, high-definition image.
    - **[Dynamic contrast]**: Enhances contrast. You can switch this feature on or off.
    - **[Dynamic backlight]**: Adjusts brightness of the TV backlight to match lighting conditions.
    - **[Colour enhancement]**: Makes colours more vivid and improves the details in bright colours. You can switch this feature on or off.
  - **[PC mode]**: Adjusts the picture when a PC is connected to the TV via HDMI or DVI.
  - **[Picture format]**: Changes the picture format.

- **[Picture size]:** Adjusts the viewing area. (when set to maximum, you might see noise or a rough edge of an image.)
- **[Horizontal shift]:** Adjusts the picture horizontally for PC-VGA input.
- **[Vertical shift]:** Adjusts the picture vertically for PC-VGA input.

## Change picture format

- 1 Press **FORMAT**.  
↳ A picture format bar appears.
- 2 Press **▲▼** to select a picture format.  
↳ The selected picture format is activated.
- 3 Press **OK** to confirm your choice.

## Summary of picture formats

The following picture settings can be configured.



### Note

- Depending on the format of the picture source, some picture settings are not available.



**[Auto format]:** (Not for HDMI, YPbPr or PC mode.) Automatically displays the suitable picture format. If not, widescreen is applied.



**[Super zoom]:** (Not for HD and PC mode.) Removes the black bars on the side of 4:3 broadcasts. There is minimal distortion.



**[4:3]:** Shows the classic 4:3 format.

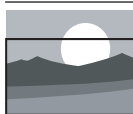

**[Subtitle zoom]:** Displays 4:3 pictures over the full area of the screen, with sub-titles visible. Part of the top of the picture is clipped off.



**[Movie expand 14:9]:** (Not for HD and PC mode.) Scales 4:3 format to 14:9.



**[Movie expand 16:9]:** (Not for HD and PC mode.) Scales 4:3 format to 16:9.



**[Wide screen]:** Scales 4:3 format to 16:9.



**[Unscaled]:** Available in selected models with PC resolution under 1024 x 768, only. Allows maximum sharpness. Some distortion may be present due to the broadcaster's systems. Set your PC resolution to wide screen mode for best results.

---

## Use smart sound

Use smart sound to apply pre-defined sound settings.

- 1 Press **♪ SOUND**.  
↳ The **[Smart sound]** menu appears.
- 2 Press **▲▼** to select the following settings.
  - **[Standard]**: Adjusts sound settings to suit most environments and types of audio.
  - **[News]**: Applies settings for spoken audio, such as news.
  - **[Movie]**: Applies settings for movies.
  - **[Custom]**: Applies the settings that were customised in the sound menu.
- 3 Press **OK** to confirm your choice.  
↳ The selected smart sound setting is applied.

---

## Manually adjust sound settings

- 1 Press **⬆ MENU**.
- 2 Press **▲▼◀▶** to select **[Setup] > [Sound]**.  
↳ The **[Sound]** menu appears.
- 3 Press **▲▼◀▶** to select the following settings.
  - **[Smart sound]**: Accesses pre-defined smart sound settings.
  - **[Bass]**: Adjusts the bass level.
  - **[Treble]**: Adjusts the treble level.
  - **[Volume]**: Adjusts the volume.
  - **[Balance]**: Adjusts the balance of the right and left speakers.
  - **[Dual I-II]**: Selects audio languages if dual sound broadcast is available.
  - **[Mono/Stereo]**: Selects mono or stereo if stereo broadcast is available.
  - **[TV speakers]**: Turns TV speakers on or off. Setting TV speakers to automatic mode turns off the speakers when content from an EasyLink-compliant home theatre system is detected.(Only available if EasyLink is switched on.)
  - **[Surround]**: Enables spatial sound.

- **[Auto volume]**: Automatically reduces sudden volume changes, for example, when switching channels.
- **[Delta volume]**: Levels out volume differences between channels or connected devices. Switch to the connected device before you change the delta volume.

---

## Use advanced teletext features

---

### Access the teletext options menu

Access the teletext features through the teletext options menu.

- 1 Press **MHEG/TELETEXT**.  
↳ The teletext screen appears.
- 2 Press **☑ OPTIONS**.  
↳ The teletext options menu appears.
- 3 Press **▲▼** to select one of the following options.
  - **[Freeze page]**: Freezes the current page.
  - **[Dual/Full screen]**: Enables and disables dual screen teletext.
  - **[Reveal]**: Hides or reveals hidden information on a page, such as solutions to riddles or puzzles.
  - **[Cycle subpage]**: Cycles through subpages automatically if subpages are available.
  - **[Language]**: Switches to a different language group to display a language correctly when it uses a different character set.
- 4 Press **▲▼◀▶** to make a selection, then press **OK** to confirm.
- 5 Press **↶ BACK** to exit the teletext options menu.



## Select teletext subpages

A teletext page can hold several subpages. Subpages are displayed on a bar next to the main page number.

- 1 Press **MHEG/TELETEXT**.  
↳ The teletext screen appears.
- 2 Press **P +/-** to select a teletext page.
- 3 Press **◀▶** to enter a subpage.

## Select T.O.P. teletext broadcasts

Table Of Pages (T.O.P.) teletext broadcasts allow you to jump from one subject to another without using page numbers. T.O.P. teletext is not broadcast on all TV channels.

- 1 Press **MHEG/TELETEXT**.  
↳ The teletext screen appears.
- 2 Press **□ INFO**.  
↳ The T.O.P. overview appears.
- 3 Press **▲▼◀▶** to select a subject.
- 4 Press **OK** to view the page.

## Create and use list of favourite channels

You can create a list of your preferred TV channels so that you can find those channels easily.

### Select a favourite list

- 1 When watching TV, press **OK** to display the channel grid.
- 2 Press **□ OPTIONS**.  
↳ The channel options menu appears.
- 3 Press **▲▼** to select **[Select list]**, then press **OK** to enter.  
↳ The channel list options appear.
- 4 Select **[Favourite]**, then press **OK**.  
↳ Only channels in the favourite list appear in the channel grid.



#### Note

- The favourite channel grid is empty until you add channels into the favourite lists.

### View all channels

You can exit a favourite list, and view all installed channels.

- 1 When watching TV, press **OK**.  
↳ The channel grid appears.
- 2 Press **□ OPTIONS**.  
↳ The channel options menu appears.
- 3 Press **▲▼** to select **[Select list]**, then press **OK** or **▶** to enter.
- 4 Select **[All]**, then press **OK**.  
↳ All channels are displayed in the channel grid.



#### Note

- All favourite channels are marked by an asterisk when you view the channel grid.

---

## Add a channel to a favourite list

- 1 When watching TV, press **OK**.  
↳ The channel grid appears.
- 2 Press **▲▼◀▶** to select a channel to add to a favourite list.
- 3 Press **☰** **OPTIONS**.  
↳ The channel options menu appears.
- 4 Select **[Mark as favourite]**, then press **OK**.  
↳ The channel is added to the favourite list.

### Note

- All favourite channels are marked by an asterisk in the channel grid.

---

## Remove a channel from a favourite list

- 1 When watching TV, press **OK**.  
↳ The channel grid appears.
- 2 Press **▲▼◀▶** to select a channel to remove.
- 3 Press **☰** **OPTIONS**.
- 4 Select **[Unmark as fav.]**, then press **OK**.
- 5 Select **[Yes]**, then press **OK**.  
↳ The channel is removed.

---

## Use the TV clock

You can display a clock on the TV screen.

---

### Set the TV clock

- 1 Press **▲** **MENU**.
- 2 Select **[Setup]** > **[Features]** > **[Clock]**  
↳ The **[Clock]** menu appears.
- 3 Press **▲▼◀▶** or **Numeric buttons** to enter time.
- 4 Select **[Done]** and press **OK** to confirm.
- 5 Press **▲** **MENU** to exit.

---

## Display the TV clock

- 1 When watching TV, press **☰** **OPTIONS**.  
↳ The TV option menu appears.
- 2 Select **[Clock]**.
- 3 Press **OK**.

---

## Use timers

You can set timers to switch the TV to standby at a specified time.

### Tip

- Set the TV clock before you use timers.

---

## Automatically switch the TV to standby (sleep timer)

Sleep timer switches the TV to standby after a pre-defined period of time.

### Tip

- You can switch off your TV earlier or reset the sleep timer during the countdown.

- 1 Press **▲** **MENU**.
- 2 Press **▲▼◀▶** to select **[Setup]** > **[Features]** > **[Sleep timer]**.  
↳ The **[Sleep timer]** menu appears.
- 3 Press **◀▶** to select a value between zero and 180 minutes.  
↳ The sleep timer can be set in steps of five minutes. If set to zero, the sleep timer is switched off.
- 4 Press **OK** to switch on the sleep timer.  
↳ The TV switches to standby after the specified time.

## Automatically switch the TV on (on timer)

You can switch on the TV from standby to a specific channel at a specified time.

- 1 Press **MENU**.
- 2 Press **▲▼◀▶** to select **[Setup]** > **[Features]** > **[On timer]**.
- 3 Press **▶** to enter the **[On timer]** menu.
  - **[Activate]**: Selects how often the TV is switched on.
  - **[Time]**: Sets the time to switch on the TV.
  - **[Programme no.]**: Selects the channel or the connected device.
- 4 Press **MENU** to exit.



Tip

- Select **[On timer]** > **[Activate]** > **[Off]** to disable this feature.

## Use TV locks

You can prevent your children from watching certain programmes or channels by locking the TV controls.

### Set or change your PIN code

- 1 Press **MENU**.
- 2 Press **▲▼◀▶** to select **[Setup]** > **[Features]** > **[Set code]** / **[Change code]**.
  - ↳ The **[Set code]** / **[Change code]** menu appears.
- 3 Enter your code using the **Numeric buttons**.
  - ↳ Follow the on-screen instructions to create or change your PIN code.



Tip

- If you forget your code, enter '8888' to override any existing codes.

## Lock or unlock the TV

Lock the TV to prevent access to all channels and connected devices.

- 1 Press **MENU**.
- 2 Press **▲▼◀▶** to select **[Setup]** > **[Features]** > **[TV lock]**.
  - ↳ You are prompted to enter your PIN code.
- 3 Enter your code using **Numeric buttons**.
  - ↳ The **[TV lock]** menu appears.
- 4 Press **▲▼** to select **[Lock]** or **[Unlock]**.
- 5 Press **OK** to confirm.
  - ↳ All channels and connected devices are locked or unlocked.
- 6 Press **MENU** to exit.



Note

- Switch the TV off and on again for the change to take effect.
- If you select **[Lock]**, you have to enter your code every time you turn on your TV.

## Lock or unlock one or more channels

- 1 When watching TV, press **OK** to display the channel grid.
- 2 Press **▲▼◀▶** to select a channel to lock or unlock.
- 3 Press **OPTION**.
- 4 Press **▲▼** to select **[Lock channel]** or **[Unlock channel]**.
- 5 For each selection, press **OK** to lock or unlock the channel.
  - ↳ You are prompted to enter your PIN code.
- 6 Enter your code and press **OK**.
  - ↳ If the channel is locked, a lock icon is displayed.

- 7 Repeat the process to lock or unlock more channels.

#### Note

- Switch the TV off and on again for the change to take effect.
- If you access the locked channels by pressing **P +/-** on the remote control or from the channel grid, you are prompted to enter your PIN code.

---

## View photos and play music from a USB storage device

#### Caution

- Philips is not responsible if the USB storage device is not supported, nor is it responsible for damage or loss of data from the device.

Use the USB connector to view photos or listen to music stored on a USB storage device.

- 1 Turn on the TV.
- 2 Connect the USB storage device to the TV.  
↳ The home menu appears.
- 3 Press **▲▼◀▶** to select **[Browse USB]**.
- 4 Press **OK** to confirm.  
↳ The USB thumbnail browser appears.

#### Tip

- Press **GUIDE** to switch between thumbnail and file browsing views.

---

## View photos

- 1 In the USB browser, press **▶** to enter the **[Picture]** folder.
- 2 Press **▲▼◀▶** to select a photo or a photo album.
- 3 Press **OK** to view a full screen image of the photo.

#### Tip



- When in full screen mode, press **◀▶** to move between photos.

---

## View a slide show of your photos

- 1 When a full screen image of a photo is displayed, press **OK**.  
↳ A slide show begins from the selected photo.
- 2 Press the following buttons to control the slide show:
  - **OK** to pause the slide show.
  - **◀▶** to go back or move forward to the next image.
  - **↶ BACK** to stop the slide show.



## Change slide show settings

- 1 When viewing a slide show, press  **OPTIONS**.  
↳ The slide show options menu appears.
- 2 Press  to select one of the following.
  - **[Start Slideshow] / [Stop Slideshow]**: Starts or stops a slide show.
  - **[Slideshow transitions]**: Sets the transition from one picture to the next.
  - **[Slideshow frequency]**: Sets the amount of time that a picture is shown.
  - **[Rotate image]**: Rotates a picture.
  - **[Show info]**: Displays the picture name, date, size and next picture in the slide show.
- 3 Press **OK** to confirm your setting.

### Note

- **[Rotate image]** and **[Show info]** appear only when you press **OK** to pause the slideshow.

## Listen to music

- 1 In USB browser view, select **[MUSIC]** and press  to enter.
- 2 Press  to select a music track or album.
- 3 Press **OK** to play the selected music.

Button	Function
<b>OK</b>	Pause, resume play or stop playback.
	Go to the previous or next music.

## Music settings

When listening to music, press  **OPTIONS** to access one of the following music settings.

- **[Start playback] / [Stop playback]**: Starts or stops the music.
- **[Play mode]**:
  - **[Play once]**: Disables repeat play and plays a song once.
  - **[Repeat]**: Repeats a song.
  - **[Shuffle]**: Plays songs randomly.
- **[Show info]**: Displays the file name.
- **[Sound]**: Adjusts the sound setting.
- **[TV speakers]**: Sets the TV speakers on or off. (Only available if EasyLink is switched on.)

## View a slideshow with music

You can view a picture slide show with background music.

- 1 Select an album of songs.
- 2 Press **OK**.
- 3 Press  **BACK** to return to the USB content browser.
- 4 Select an album of pictures.
- 5 Press **OK**.

## Disconnect a USB storage device

### Caution

- Follow this procedure to avoid damage to your USB storage device.

- 1 Press  **BACK** to exit the USB browser.
- 2 Wait for five seconds then disconnect the USB storage device.

---

## Update the TV software

Philips continuously tries to improve its products and we recommend that you update the TV software when updates are available. Check [www.philips.com/support](http://www.philips.com/support) for availability.

---

### Check the current software version

- 1 Press **MENU**.
- 2 Press **▲▼◀▶** to select **[Setup] > [Software update] > [Current software]**.  
↳ The TV displays the current software information.

---

### Download the software

- 1 On your PC, open a web browser and go to [www.philips.com/support](http://www.philips.com/support).
- 2 Download the latest software upgrade file to your PC.
- 3 Decompress the ZIP-file.
- 4 Copy the `autorun.upg` file to the root directory of the USB device.

---

### Update using a USB device

Connect your USB device to the USB port at the side of your TV.

- 1 If the software update screen does not appear automatically, select **[Setup] > [Software update] > [Local updates]**.
- 2 Press **OK** to update the TV software manually.
- 3 Follow the on-screen instructions to complete the update.

#### Note

- The TV restarts after the software update is complete.

---

## Change TV preferences

Use the preferences menu to customise your TV settings.

- 1 Press **MENU**.
- 2 Select **[Setup] > [Installation] > [Preferences]**.
  - **[Location]**: Optimises TV settings for your location - home or shop.
  - **[Volume bar]**: Displays the volume bar when you adjust the volume.
  - **[EasyLink]**: Enables one-touch play and one-touch standby between EasyLink-compliant devices.
  - **[Pixel Plus Link]**: Overrides the settings of connected devices and uses the settings of the TV. (Only available if EasyLink is switched on.)
  - **[E-sticker]**: For shop mode only. Sets the location of the e-sticker.
- 3 Press **▲▼◀▶** to select your preference.
- 4 Press **OK**.
- 5 Press **MENU** to exit.

## Access decoder channel

You can map channels provided through a decoder or descrambler to your TV channel selection. In this way, you can select these channels by using the RC of your TV. The decoder or a descrambler must be connected to EXT1 (SCART).

### Set decoder channel

Map channels from a decoder or descrambler.

- 1 Press **MENU**.
- 2 Select **[Setup] > [Installation] > [Decoder]**.
- 3 Press **▶** to enter **[Decoder]** menu.
- 4 Press **▲▼** to select **[Channel]**, then press **▶** to enter.
- 5 Select one channel to map to the decoder / descrambler channel and press **OK** to confirm.
- 6 Select **[Status]**, then press **▶** to enter.
- 7 Select **[EXT 1]** (SCART) the connector used by the decoder / descrambler.
- 8 Press **OK**.
- 9 Press **MENU** to exit.

#### Note

- Select **[None]** if you do not want to map to the decoder / descrambler channel.

## Start a TV demo

You can use demonstrations to better understand the features of your TV. Some demos are not available on certain models. Available demos are displayed in the menu list.

- 1 Press **DEMO** on the remote control.
- 2 Press **▲▼** to select a demo and press **OK** to view it.
- 3 Press **↵ BACK** to exit.

## Reset the TV to factory settings

You can restore the default picture and sound settings of your TV. The channel installation settings remain the same.

- 1 Press **MENU**.
- 2 Select **[Setup] > [Installation] > [Factory settings]**.
- 3 Press **▶** to enter **[Factory settings]**.
- 4 Select **[Reset]** to start resetting.
- 5 Press **OK**.
- 6 Press **MENU** to exit.

# 6 Install channels

The first time you set up your TV, you are prompted to select a menu language and to install TV and digital radio channels (if available). This chapter provides instructions on how to re-install and fine tune channels.

---

## Automatically install channels

This section describes how to search and store channels automatically.

---

### Step 1 Select your menu language

 **Note**

- Skip this step if your language settings are correct.

- 1 Press **MENU**.
- 2 Press **▲▼◀▶** to select **[Setup] > [Installation] > [Menu language]**.
- 3 Press **▶** to enter **[Menu language]**.
- 4 Press **▲▼** to select a language.
- 5 Press **OK** to confirm.
- 6 Press **MENU** to exit.

---

### Step 2 Select your country

Select the country where you are installing the TV. The available channels for the country are installed on the TV.

- 1 Press **MENU**.
- 2 Select **[Setup] > [Installation] > [Channel installation] > [Channel assistant]**.  
↳ The **[Channel assistant]** menu appears.
- 3 Select **[Yes]**, then press **OK** to enter.
- 4 Press **▲▼** to select your country, then press **▶** to go to the next step.

- 5 Select **[Start]**, then press **OK** to re-install channels.
  - To stop searching, select **[Stop]** and press **OK**.
- 6 Press **MENU** to exit.

---

## Manually install channels

This section describes how to search and store analogue TV channels manually.

---

### Step 1 Select your system

 **Note**

- Skip this step if your system settings are correct.

- 1 Press **MENU**.
- 2 Press **▲▼◀▶** to select **[Setup] > [Installation] > [Channel installation] > [Analogue: Manual]**.  
↳ The **[Analogue: Manual]** menu appears.
- 3 Select **[System]**, then press **OK** to enter.
- 4 Press **▲▼** to select your country or region.
- 5 Press **OK** to confirm.
- 6 Press **MENU** to exit.

---

### Step 2 Search and store new TV channels

- 1 Press **MENU**.
- 2 Press **▲▼◀▶** to select **[Setup] > [Installation] > [Channel installation] > [Analogue: Manual]**.  
↳ The **[Analogue: Manual]** menu appears.
- 3 Press **▲▼** to select **[Search]**, then press **▶** to enter.
- 4 Press **Numeric buttons** to manually enter the three-digit frequency.



- 5 Press **OK** to begin search.  
↳ If a channel is unavailable at the selected frequency, the system searches for the next available channel.
- 6 Press **↶ BACK** when the new channel is found.
- 7 Press **▲▼** to select **[Store as new channel]** to store the new channel under a new channel number.
- 8 Press **▶** to enter **[Store as new channel]**.
- 9 Select **[OK]**, then press **OK** to store the new channel.
- 10 Press **⏠ MENU** to exit.

---

### Step 3 Fine-tune analogue channels

- 1 Press **⏠ MENU**.
- 2 Press to select **[Setup] > [Installation] > [Channel installation] > [Analogue: Manual]**.  
↳ The **[Analogue: Manual]** menu appears.
- 3 Press **▲▼** to select **[Fine-tune]**, then press **▶** to enter.
- 4 Press **▲▼** to adjust frequency.
- 5 Press **OK** to confirm.
- 6 Press **▲▼** to select **[Store current channel]** to store channel number.
- 7 Press **▶** to enter **[Store current channel]**.
- 8 Select **[OK]**, then press **OK** to store current channel.
- 9 Press **⏠ MENU** to exit.

---

### Skip channels

- 1 When watching TV, switch to the channel you want to skip.
- 2 Press **⏠ MENU**.
- 3 Press **▲▼◀▶** to select **[Setup] > [Installation] > [Channel installation] > [Analogue: Manual]**.  
↳ The **[Analogue: Manual]** menu appears.
- 4 Press **▲▼** to select **[Skip channel]**, then press **▶** to enter.
- 5 Press **▲▼** to select **[Yes]**, then press **OK** to skip current channel.  
↳ The selected channel is skipped when you press **P +/-** on your remote control or view from the channel grid.
- 6 Repeat the previous steps to skip more channels.



#### Tip

- Press the **Numeric buttons** on the remote control to access the skipped channel.
- To access the skipped channel, repeat steps 1-5 and select **[No]** to restore.

---

## Rename channels

You can rename channels. The name appears when you select the channel.

- 1 When watching TV, press **OK** to display the channel grid.
- 2 Select the channel to rename.
- 3 Press **⏻** **OPTIONS**.  
↳ The channel options menu appears.
- 4 Press **▲▼** to select **[Rename channel]**, then press **OK**.  
↳ A text input box appears.
- 5 Press **▲▼◀▶** to select characters.
- 6 Press **OK** to confirm each character.
- 7 Select **[Done]**, then press **OK** to finish renaming channels.



Tip

- The device name can be up to six characters long.
- Press **[Aa]** to change an uppercase letter to a lowercase letter and vice versa.

---

## Rearrange channels

After you install channels, you can rearrange the order in which they appear.

- 1 When watching TV, press **OK** to display the channel grid.
- 2 Press **⏻** **OPTIONS**.  
↳ The channel options menu appears.
- 3 Press **▲▼** to select **[Reorder]**, then press **OK**.
- 4 Select the channel to rearrange, then press **OK**.  
↳ The selected channel is highlighted.
- 5 Press **▲▼◀▶** to move the highlighted channel to the desired location, then press **OK**.
- 6 Press **⏻** **OPTIONS**.  
↳ **[Done reordering]** appears on the screen.
- 7 Press **OK** to confirm.
- 8 Press **⏪** **BACK** to exit the channel grid.

# 7 Connect devices

This section describes how to connect devices with different connectors. Examples are provided in the Quick Start.

## Note

- You can use different types of connectors to connect a device to your TV.

## Back connector

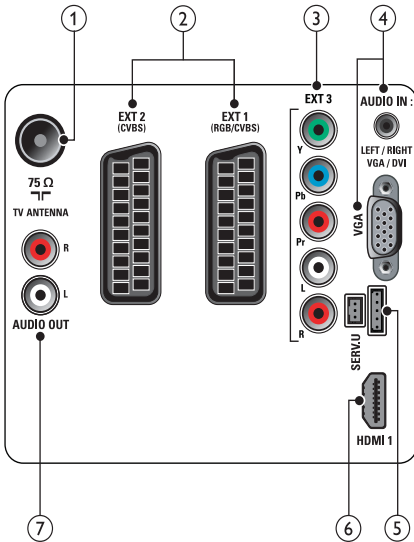

### ① TV ANTENNA

Signal input from an antenna, cable or satellite.

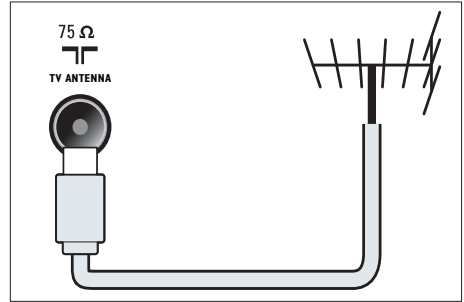

### ② EXT 1 and EXT 2 (CVBS and RGB)

Analogue audio and video input from analogue or digital devices such as DVD players or game consoles.

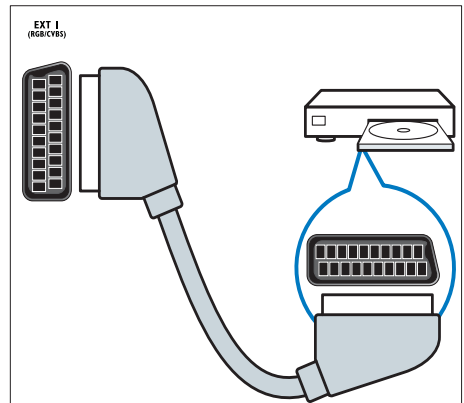

③ **EXT 3 (Y Pb Pr and AUDIO L/R)**

Analogue audio and video input from analogue or digital devices such as DVD players or game consoles.

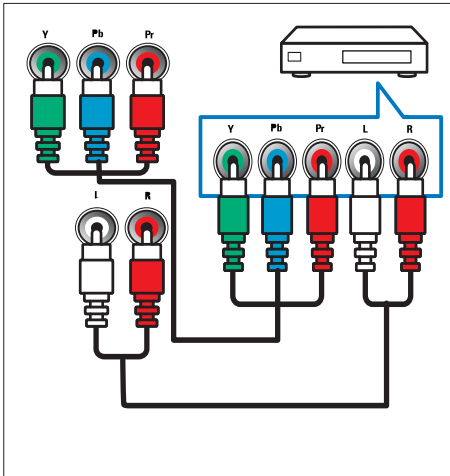

⑥ **HDMI 1**

Digital audio and video input from high-definition digital devices such as Blu-ray players.

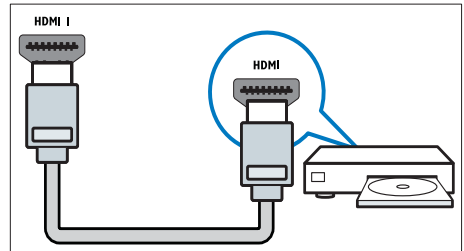

Connections via DVI or VGA require an additional audio cable (see 'Connect a computer' on page 28).

④ **PC IN (VGA and AUDIO IN)**

Audio and video input from a computer.

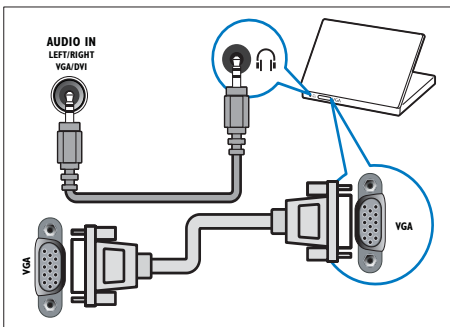

⑤ **SERV. U**

For use by service personnel only.

## Side connector

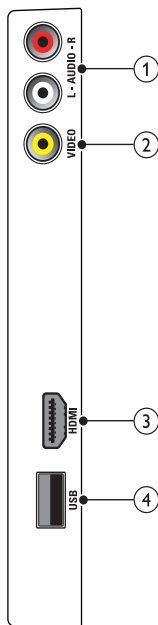

### ① AUDIO L/R

Audio input from analogue devices connected to VIDEO.

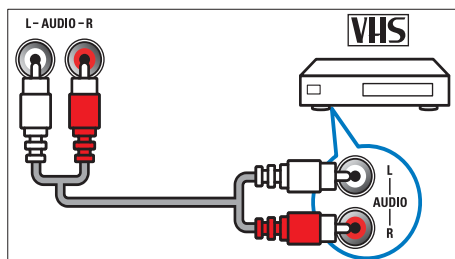

### ② VIDEO

Composite video input from analogue devices such as VCRs.

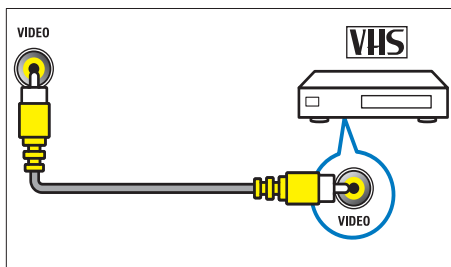

### ③ HDMI

Digital audio and video input from high-definition digital devices such as Blu-ray players.

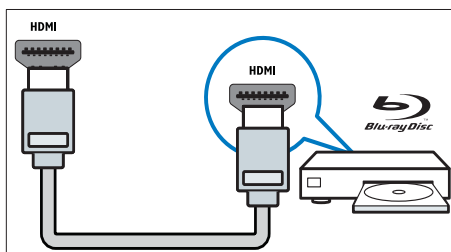

### ④ USB

Data input from USB storage devices.

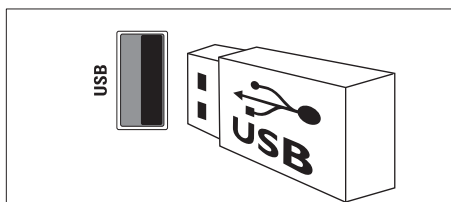

## Connect a computer

Before you connect a computer to the TV

- Set the screen refresh rate on your computer to 60Hz.
- Select a supported screen resolution on your computer.

Connect a computer with one of the following connectors:

### Note

- Connections via DVI or VGA require an additional audio cable.

- HDMI cable

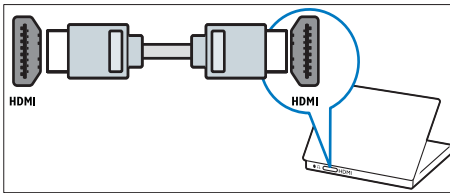

- DVI-HDMI cable

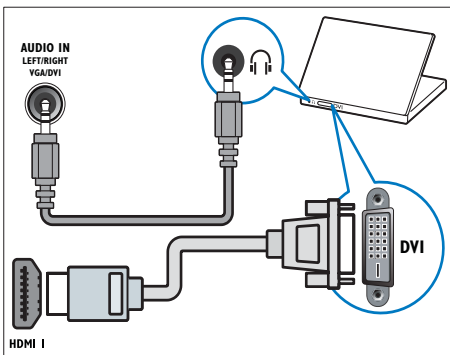

- HDMI cable and HDMI-DVI adaptor

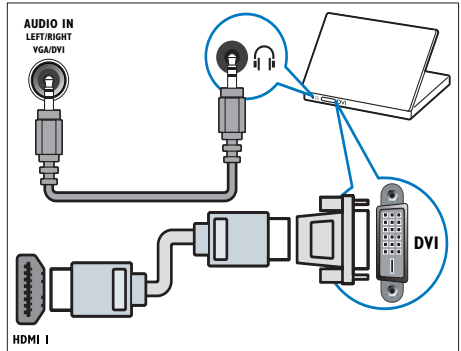

- VGA cable

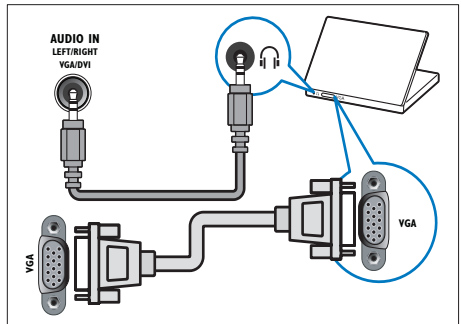

## Use Philips EasyLink

Your TV supports Philips EasyLink, which uses the HDMI CEC (Consumer Electronics Control) protocol. EasyLink-compliant devices that are connected through HDMI connectors can be controlled by a single remote control.

### Note

- The EasyLink-compliant device must be switched on and selected as the source.
- Philips does not guarantee 100% interoperability with all HDMI CEC devices.

## EasyLink features

### One-touch play

When you connect your TV to devices that support one-touch play, you can control your TV and the devices with one remote control.

### One-touch standby

When you connect your TV to devices that support standby, you can use your TV remote control to put your TV and all connected HDMI devices in standby mode.

### System audio control

When you connect your TV to HDMI CEC compliant devices, your TV can switch automatically to play audio from the connected device.

To use one-touch audio, you must map the audio input from the connected device to your TV.

You can use the remote control from the connected device to adjust the volume.

## Enable or disable EasyLink

### Note

- Do not enable Philips EasyLink if you do not intend to use it.

- 1 Press **MENU**.
- 2 Press **▲▼◀▶** to select **[Setup] > [Installation] > [Preferences] > [EasyLink]**.
- 3 Select **[On]** or **[Off]**.

## Use one-touch play

- 1 After enabling EasyLink, press play on your device.
  - ↳ The TV automatically switches to the correct source.

## Use one-touch standby

- 1 Press **⏻ (Standby-On)** on the TV's or device's remote control.
  - ↳ The TV and all connected HDMI devices switch to standby.

## Set TV speakers to EasyLink mode

When you play content from an EasyLink compliant home theater, the TV speakers are automatically muted.

- 1 Enable one-touch play and one-touch standby between your Easylink compliant devices by following the instructions in the previous section (see 'Enable or disable EasyLink' on page 29).
- 2 Press **MENU**.
- 3 Press **▲▼◀▶** to select **[Setup] > [Sound] > [TV speakers] > [Auto EasyLink]**.
  - ↳ The TV speakers are turned off automatically when content from an Easylink compliant system is detected.
- 4 Press **▲▼◀▶** to select **[Setup] > [Sound] > [TV speakers] > [On]** to disable system audio control and enable the TV speakers.

### Note

- To mute the TV speakers, select **[TV speakers] > [Off]**.

---

## Use a Kensington lock

There is a Kensington security slot at the back of the TV. Prevent theft by looping a Kensington lock between the slot and a permanent object, such as a heavy table.

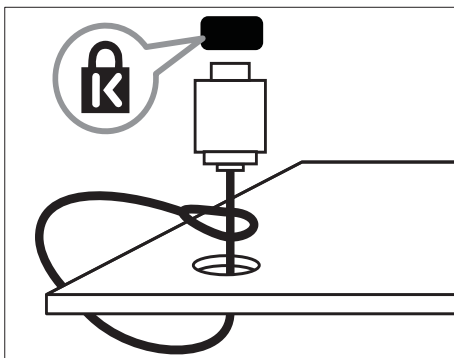



# 8 Product information

Product information is subject to change without notice. For detailed product information, go to [www.philips.com/support](http://www.philips.com/support).

## Supported display resolutions

### Computer formats

- Resolution - refresh rate:
  - 640 × 480 - 60Hz
  - 800 × 600 - 60Hz
  - 1024 × 768 - 60Hz
  - 1280 × 768 - 60Hz
  - 1280 × 1024 - 60 Hz
  - 1360 × 768 - 60Hz
  - 1440 × 900 - 60Hz
  - 1680 × 1050 - 60Hz

### Video formats

- Resolution - refresh rate:
  - 480i - 60Hz
  - 480p - 60Hz
  - 576i - 50Hz
  - 576p - 50Hz
  - 720p - 50Hz, 60Hz
  - 1080i - 50Hz, 60Hz
  - 1080p - 24Hz, 25Hz, 30Hz, 50Hz, 60Hz.

## Multimedia

- Supported storage device: USB (Only FAT or FAT 32 USB storage devices are supported)
- Supported multimedia file formats:
  - Images: JPEG
  - Audio: MP3

## Tuner / Reception / Transmission

- Aerial input: 75ohm coaxial (IEC75)
- TV system: PAL I, B/G, D/K; SECAM B/G, D/K, L/L'
- Video playback: NTSC, SECAM, PAL
- Tuner Bands: Hyperband, S-channel, UHF, VHF

## Remote control

- Type: PF02E09B
- Batteries: 2 × AAA (LR03 type)

## Power

- Mains power: 220-240V, 50Hz
- Standby power: < 1 W
- Ambient temperature: 5 to 40 degrees Celsius

## Supported TV mounts

To mount the TV, purchase a Philips TV mount or a VESA-compatible TV mount. To prevent damage to cables and connectors, be sure to leave a clearance of at least 2.2 inches or 5.5cm from the back of the TV.



### Warning

- Follow all instructions provided with the TV mount. Koninklijke Philips Electronics N.V. bears no responsibility for improper TV mounting that results in accident, injury or damage.

TV screen size (inches)	Required pitch (mm)	Required mounting bolts
32	200 × 200	4 × M6 (≤ 10 mm)
42	300 × 200	4 × M6 (≤ 10 mm)

---

## Product specification

Design and specifications are subject to change without notice.

### 32PFL3605

- Without TV stand
  - Dimension (WxHxD): 795.6 × 508.3 × 93 (mm)
  - Weight: 8.3 kg
- With TV stand
  - Dimension (WxHxD): 795.6 × 556.6 × 220.8 (mm)
  - Weight: 9.4 kg

### 42PFL3605

- Without TV stand
  - Dimension (WxHxD): 1018.5 × 635.7 × 83 (mm)
  - Weight: 11.5 kg
- With TV stand
  - Dimension (WxHxD): 1018.5 × 683 × 235.8 (mm)
  - Weight: 12.8 kg

# 9 Troubleshooting

This section describes commonly encountered issues and accompanying solutions.

---

## General TV issues

### The TV does not switch on:

- Disconnect the power cable from the power outlet. Wait for one minute then reconnect it.
- Check that the power cable is securely connected.

### The remote control is not working properly:

- Check that the remote control batteries are correctly inserted according to the +/- orientation.
- Replace the remote control batteries if they are flat or weak.
- Clean the remote control and TV sensor lens.

### The standby light on the TV blinks red:

- Disconnect the power cable from the power outlet. Wait until the TV cools down before reconnecting the power cable. If the blinking reoccurs, contact Philips Consumer Care.

### You forgot the code to unlock the TV lock feature

- Enter '8888'.

### The TV menu is in the wrong language.

- Change the TV menu to your preferred language.

When turning the TV on / off / to standby, you hear a creaking sound from the TV chassis:

- No action is required. The creaking sound is normal expansion and contraction of the TV as it cools down and warms up. This does not impact performance.

### Cannot remove 'e-sticker' banner displayed on the TV.

- To remove the logos and images, set the location of your TV to home.
  1. Press **HOME** MENU.
  2. Select **[Setup] > [Installation] > [Preferences] > [Location]**.
  3. Select **[Home]** and press **OK**.

---

## TV channel issues

### Previously installed channels do not appear in the channel list:

- Check that the correct channel list is selected.

### Some channels are not automatically installed on my TV:

- During installation, make sure that you select the country where you are installing the TV (see 'Step 2 Select your country' on page 22).

---

## Picture issues

### The TV is on, but there is no picture:

- Check that the antenna is properly connected to the TV.
- Check that the correct device is selected as the TV source.

### There is sound but no picture:

- Check that the picture settings are correctly set.

### There is poor TV reception from an antenna connection:

- Check that the antenna is properly connected to the TV.
- Loudspeakers, unearthed audio devices, neon lights, high buildings and other large objects can influence reception quality. If possible, try to improve the reception quality by changing the antenna direction or moving devices away from the TV.
- If reception on only one channel is poor, fine tune this channel.

### There is poor picture quality from connected devices:

- Check that the devices are connected properly.
- Check that the picture settings are correctly set.

### The TV did not save your picture settings:

- Check that the TV location is set to the home setting. This mode offers you the flexibility to change and save settings.

### The picture does not fit the screen; it is too big or too small:

- Try using a different picture format.

### The picture position is incorrect:

- Picture signals from some devices may not fit the screen correctly. Check the signal output of the device.

---

## Sound issues

### There is a picture but sound quality is poor:



#### Note

- If no audio signal is detected, the TV automatically switches the audio output off — this does not indicate malfunction.

- Check that all cables are properly connected.
- Check that the volume is not set to 0.
- Check that the sound is not muted.

### There is a picture but the sound quality is poor:

- Check that the sound settings are correctly set.

### There is a picture but sound comes from one speaker only:

- Verify that sound balance is set to the centre.

---

## HDMI connection issues

### There are problems with HDMI devices:

- Note that HDCP (High-bandwidth Digital Content Protection) support can delay the time taken for a TV to display content from a HDMI device.
- If the TV does not recognise the HDMI device and no picture is displayed, try switching the source from one device to another and back again.
- If there are intermittent sound disruptions, check that output settings from the HDMI device are correct.
- If you use an HDMI-to-DVI adapter or HDMI-to-DVI cable, check that an additional audio cable is connected to **AUDIO IN** (mini-jack only).

---

## Computer connection issues

### The computer display on the TV is not stable:

- Check that your PC uses the supported resolution and refresh rate.
- Set the TV picture format to unscaled.

---

## Contact us

If you cannot resolve your problem, refer to the FAQs for this TV at [www.philips.com/support](http://www.philips.com/support).

If the problem remains unresolved, contact Philips Consumer Care in your country as listed in this user manual.



### Warning

- Do not attempt to repair the TV yourself. This may cause severe injury, irreparable damage to your TV or void your warranty.



### Note

- Make a note of your TV model and serial number before you contact Philips. These numbers are printed on the back of the TV and on the packaging.

# 10 Index

---

## A

<b>analogue</b>	
fine-tune	23
<b>antenna</b>	25

---

## B

<b>back connectors</b>	25
<b>batteries</b>	31, 5
<b>bracket for wall mount</b>	31

---

## C

<b>care</b>	5
<b>channel decoder</b>	21
<b>channel grid</b>	9
<b>channels</b>	
favourites list	15
fine-tune	23
grid	9
install	
automatic	22
manual	22
list	15
lock	17
rename	24
reorder / rearrange	24
skip channels	23
switch	9
troubleshooting	33
tune	23
<b>child lock</b>	
lock channels	18
lock connected devices	17
PIN code	17
<b>clock</b>	
set	16
<b>computer</b>	
connect	35, 28
display resolution	31
<b>connect</b>	
antenna	25
PC	35, 28

## connectors

back connectors	25
HDMI	34, 25
overview	25
side connectors	27
USB	18

## country

22

---

## D

<b>decoder</b>	21
<b>default settings</b>	21
<b>demo</b>	21
<b>devices</b>	10
<b>devices</b>	
add to home menu	11
connect	25
remove	11
rename	11
watch	10

## digital services

teletext	10, 14
----------	--------

## disconnect USB

20

## display

resolution	31
------------	----

## dispose

5

---

## E

### EasyLink

disable	29
enable	29
one-touch play	29
one-touch standby	29
system audio control	29

### end of life

5

### environmental care

5

### e-sticker

20

---

## F

### factory settings

21

### favourites list

create list	15
view list	15

### fine-tune channels

23

<hr/>	
<b>H</b>	
HDMI	34, 25, 27
home mode	20
<hr/>	
<b>I</b>	
install channels	
automatic	22
manual	22
<hr/>	
<b>K</b>	
Kensington lock	30
<hr/>	
<b>L</b>	
language	
menu	22
troubleshoot	33
list	
favourites list	15
location	
country	22
home or shop	20
lock	
Kensington lock	30
lock channels	18
lock connected devices	17
PIN code	17
<hr/>	
<b>M</b>	
menu	
language	22
main menu	11
teletext	14
MHEG teletext	10
MPEG artifact reduction	12
multimedia	31
music	
USB	19
with slideshow	19
mute TV speakers	29
<hr/>	
<b>O</b>	
on timer	16
one-touch play	29
one-touch standby	29
<hr/>	
<b>P</b>	
PC	
connect	28, 35
resolution	31
picture format	
change	13
troubleshooting	34
picture settings	12
PIN code	17
pixel plus link	20
power	31
power consumption	31
preferences	20
product specifications	31
<hr/>	
<b>R</b>	
rearrange channels	24
reception	34
recycle	5
register product	7
remote control	
batteries	31, 5
overview	7
technical specifications	31
rename channels	24
reorder channels	24
resolution	31
restore default	21

---

<b>S</b>	
safety	4
screen care	5
<b>settings</b>	
picture	12
sound	14
<b>shop mode</b>	20
<b>side connectors</b>	27
<b>skip channels</b>	23
<b>slideshow</b>	
view	19
with music	19
<b>smart picture</b>	12
<b>smart settings</b>	12, 14
<b>smart sound</b>	14
<b>software</b>	
version	20
<b>sound settings</b>	14
<b>specifications</b>	31
<b>standby</b>	9
<b>subpages in teletext</b>	15
<b>switch</b>	
channels	9
on and off	9
source	10

---

<b>T</b>	
<b>Table of Pages</b>	15
<b>technical specifications</b>	31
<b>teletext</b>	
features	14
menu	14
subpages	15
Table of Pages	15
use	10
<b>timer</b>	
on timer	17
sleep timer	16
standby	16
<b>transmission</b>	31, 33
<b>transporting</b>	4
<b>troubleshooting</b>	33
<b>TV lock</b>	
lock channels	18
lock connected devices	17
PIN code	17
<b>TV overview</b>	7

---

<b>U</b>	
<b>USB</b>	
disconnect USB	20
listen to music	19
update software	20
view photos	18

---

<b>V</b>	
<b>video format</b>	
technical specifications	31
<b>volume</b>	
adjust	10
automatic levelling	14
delta	14
mute	10, 29

---

<b>W</b>	
<b>wall mount</b>	4, 31



# Information about how to re-tune your TV during the digital TV switchover.

**Keep this user manual safe – you'll need it.**

.....

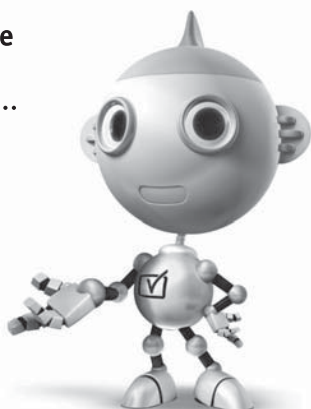

Television in the UK is going digital, bringing us all more choice and new services. Starting in late 2007 and ending in 2012, television services in the UK will go completely digital, TV region by TV region.

Please see the next page to find out when your area switches to digital.

Digital UK is the independent, non-profit organisation leading the process of digital TV switchover in the UK. Digital UK provides impartial information on what people need to do to prepare for the move to digital, and when they need to do it.

## How the switchover affects your TV equipment:

Your new TV has a digital tuner built in, which means it is ready to receive the Freeview signal by simply plugging it into your aerial socket (check if you can get digital TV through your aerial now, or whether you'll have to wait until switchover, at [www.digitaluk.co.uk](http://www.digitaluk.co.uk)).

When the TV switchover happens in your area, there are at least two occasions when you will need to re-tune your TV in order to continue receiving your existing TV channels, and also to pick up new ones.

get set for digital 

Digital UK, the body leading the digital TV switchover, will advise you when you need to re-tune during the switchover.

If you choose to connect your TV to satellite or cable with a digital box then it will not be affected by switchover, and you won't need to re-tune.

If you have any questions, please contact your equipment supplier or call Digital UK on ... 0845 6 50 50 50 or visit [www.digitaluk.co.uk](http://www.digitaluk.co.uk)

## How to re-tune:

To find out on how to re-tune your TV, check the user manual online for details

If you do not re-tune your channels when advised to do so by Digital UK, you may lose some or all of your channels until you do re-tune. You should re-tune your TV every few months to check for any new channels.

If you are missing any channels, it may be that they are not available in your area, or that your aerial needs upgrading.

## When does switchover happen?

\*Copeland switches on October 17, 2007

The exact date you switch depends on the transmitter you are served by. To check when you switch, go to Digital UK's postcode checker on [www.digitaluk.co.uk](http://www.digitaluk.co.uk)

Check your ITV news service or look at Teletext page 106 to see what TV region you're in.

Visit us at [digitaluk.co.uk](http://digitaluk.co.uk)  
Call us on 0845 6 50 50 50†

† Calls charged at BT rate of 3p per minute daytime and 1p per minute evenings and weekends. Rates may vary for calls from non-BT lines.



