



Operation Manual

Smart-UPS[®] UPS

750/1000/1500/2200/3000 VA Tower

120/230 VAC

Contents

- Overview 1**
 - Product Description 1
 - Safety 1
 - Product Overview 1
 - Front panels 1
 - Rear panels 2
 - Specifications 3
 - Operating Conditions 3
 - Environmental Specifications 3
 - Installation 3
 - UPS 3
 - Network Management Card 3

- Operation 4**
 - Connect Equipment to the UPS 4
 - Rear Panel Features 4
 - Display Interface 5
 - Overview 5
 - Using the display interface 5
 - Standard menus 5
 - Advanced menus 6
 - 6

- Configuration 7**
 - UPS Settings 7
 - Start-up Settings 7
 - General Settings 7
 - Main Outlet Group and the Switched Outlet Group 9
 - Overview 9
 - Using the Main Outlet Group and the Switched Outlet Group 9
 - Customize the Main Outlet Group and the Switched Outlet Group 9
 - Network Management Card Settings 10

Emergency Power Off	11
EPO Overview	11
Normally open contacts	11
Normally closed contacts	11
 Troubleshooting	 12
 Service and Support.....	 14
Service.....	14
Transport the unit	15
APC Worldwide Customer Support	15
 Smart-UPS Factory Warranty	 16
LIMITED WARRANTY	16

Overview

Product Description

The APC® by Schneider Electric Smart-UPS® 750-3000 VA 120/230 Vac Tower is a high performance Uninterruptible Power Supply (UPS). It provides protection for electronic equipment from utility power blackouts, brownouts, sags, and surges; small utility fluctuations and large disturbances. The UPS also provides battery backup power until utility power returns to safe levels or the batteries are fully discharged.

Safety



Read the Safety Guide included in the package before installing the UPS.

Inspect the UPS upon receipt. Notify the carrier and dealer if there is damage.



Recycle the packaging

Product Overview

Front panels

- ❶ Display interface 2200/3000 VA
- ❷ Bezel
- ❸ Battery
- ❹ Battery connector

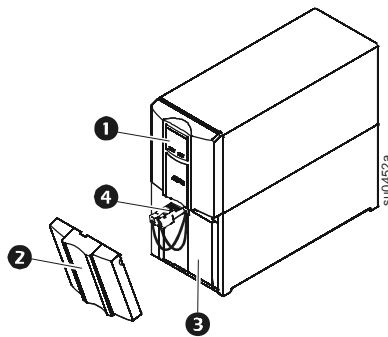

750/1000/1500 VA

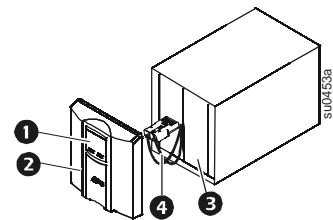

Rear panels

- ❶ USB port
- ❷ Serial port
- ❸ Ground screw
- ❹ Smart slot
- ❺ Circuit breaker
- ❻ UPS input
- ❼ Outlets
- ❽ EPO connector

750 VA 120 Vac

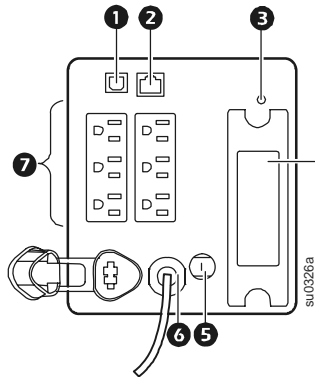

750 VA 230 Vac

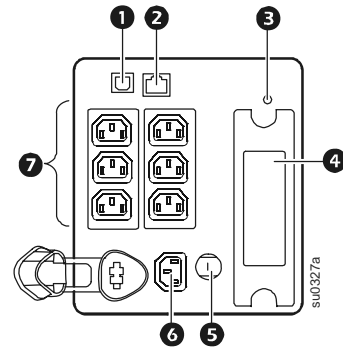

1000/1500 VA 120 Vac

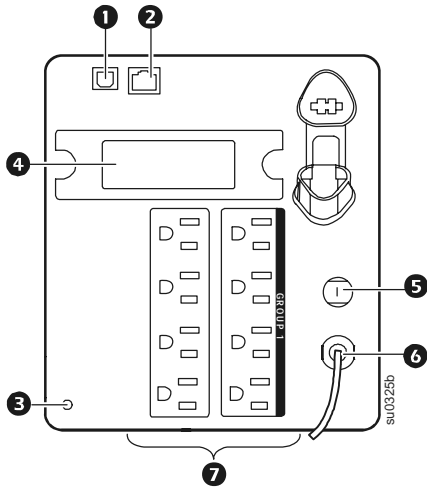

1000/1500 VA 230 Vac

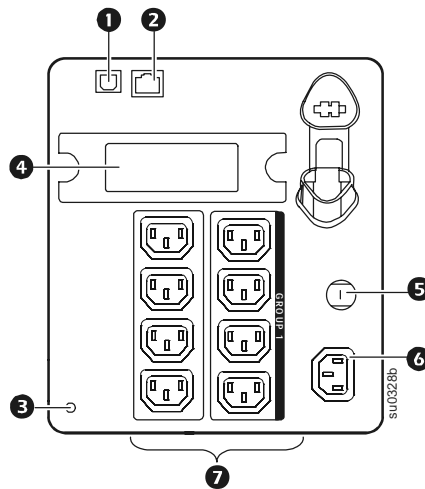

2200 VA 120 Vac/3000 VA 120 Vac†

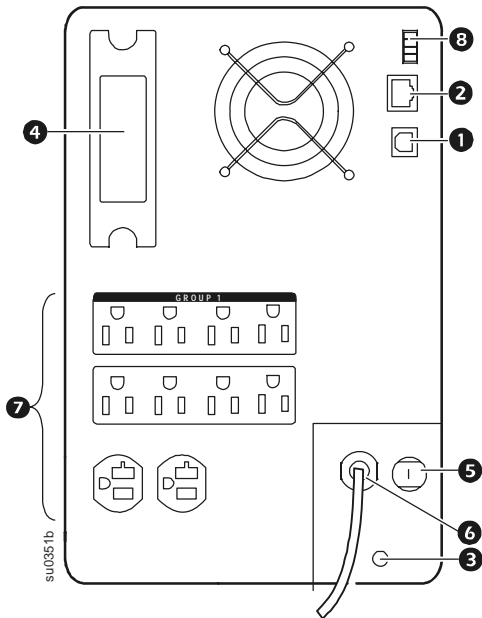

2200/3000 VA 230 Vac

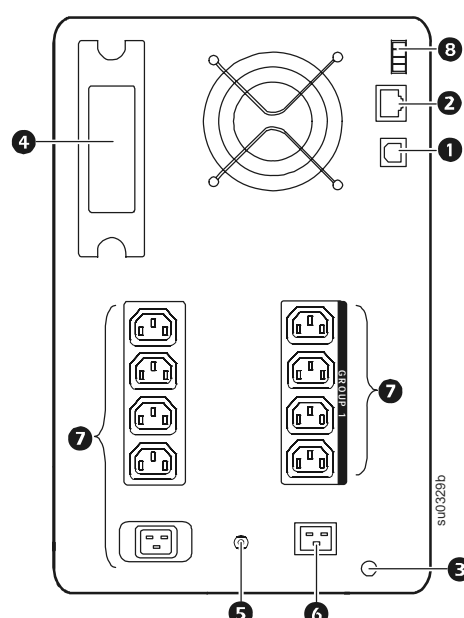

†Circuit breaker may be different than shown.

Specifications

Operating Conditions

This unit is intended for indoor use only. Select a location sturdy enough to support the weight of the UPS.

Do not operate the unit where there is excessive dust, or the temperature or humidity are outside the specified limits.

This unit has side air vents. Allow adequate space for proper ventilation.

Environmental Specifications

Environmental factors impact battery life. High temperatures, poor utility power, and frequent, short duration discharges will shorten battery life.

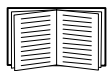

For additional specifications, see the APC Web site at www.apc.com.

Temperature	Operating	0° to 40° C (32° to 104° F)
	Storage	-15° to 45° C (5° to 113° F) charge UPS battery every six months
Maximum Elevation	Operating	3,000 m (10,000 ft)
	Storage	15,000 m (50,000 ft)
Humidity	0% to 95% relative humidity, non-condensing	

Installation

UPS

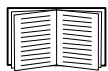

For UPS installation information, see the Smart-UPS Quick-Start Guide 750/1000/1500/2200/3000 VA 120/230 Vac Tower that is included with the UPS. The guide is also available on the enclosed CD and the APC Web site at www.apc.com.

Network Management Card

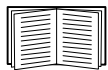

For installation information, see the user manual provided with the Network Management Card (NMC). The user manual is also available on the APC Web site at www.apc.com.

Operation

Connect Equipment to the UPS



Note: The UPS will charge to 90% capacity in the first three hours of normal operation. **Do not expect full battery run capability during this initial charge period.**

1. Connect equipment to the outlets on the rear panel of the UPS. **Do not use extension cords, plug equipment directly into the UPS.**
2. Connect the UPS to the building utility power. **Connect the UPS to a two-pole, three-wire, grounded receptacle only.**
3. Press the ON/OFF button on the front panel of the UPS to apply power to the unit and all connected equipment.
4. To use the UPS as a master on/off switch, turn on all the equipment that is connected to the UPS.

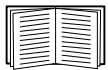

See “UPS Settings” on page 7 for information on how to configure the outlet groups.

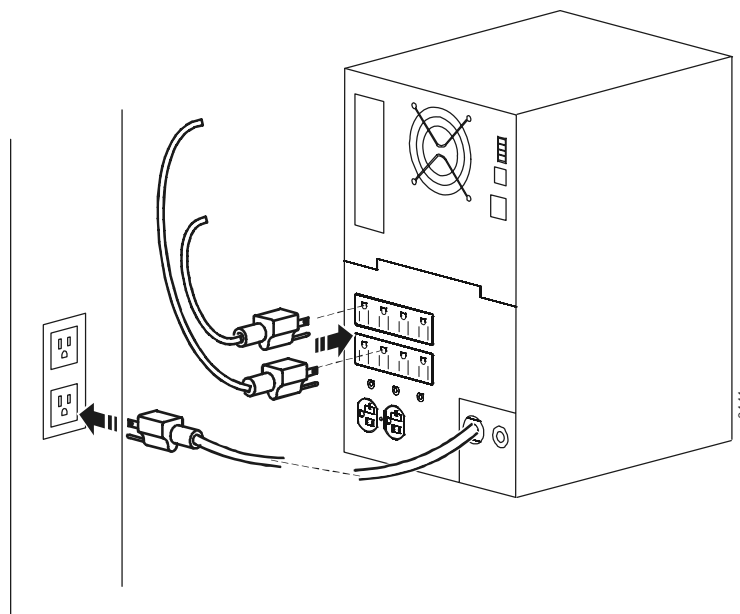

Rear Panel Features



Serial port: Connect to a computer to use power management software.



USB port: Connect to a computer to use power management software.



Ground Screw: Connect the ground leads on transient voltage devices to the chassis ground screw(s), located on the rear panel of the UPS.

Display Interface

Overview

- ❶ Online indicator
- ❷ UPS Output On/Off button
- ❸ On Battery indicator
- ❹ Fault indicator
- ❺ Replace Battery indicator
- ❻ Display screen
- ❼ UP/DOWN buttons
- ❽ ENTER button
- ❾ ESCAPE button

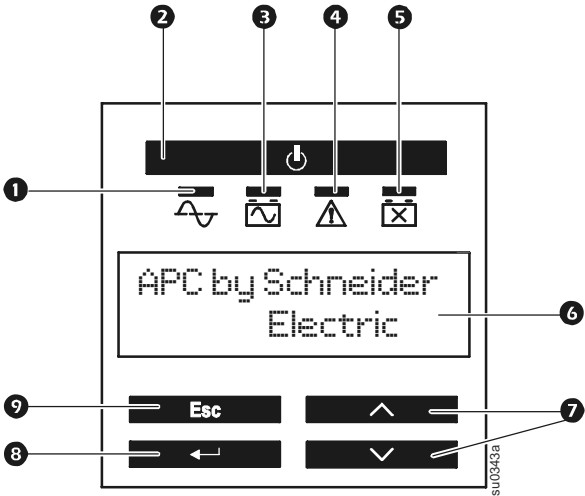

Using the display interface

Use UP and DOWN to scroll through the main menu options. Press ENTER to view the sub-menus under each main menu option. Press ESCAPE to exit a sub-menu and return to a main menu.

Standard menus

The Standard menus are the most commonly used menus for the UPS.

Menu	General Functions
Status	View basic information about the UPS: <ul style="list-style-type: none"> • Operating mode • Switched Outlet status, On or Off • Efficiency of the UPS • Information about the load • Battery capacity • Estimated runtime • Input and output voltage and frequency • Information about the last transfer to battery power • Self-test results
Configuration	Configure the settings for the UPS: <ul style="list-style-type: none"> • Language • Local power quality: Good, Fair, Poor • Choose Standard or Advanced menus • LCD Display mode, Always On or Power-Saving • Audible alarms • Reset to Factory Defaults
Test & Diags	Use the Test & Diags menu to have the UPS perform a self-test.

Menu	General Functions
About	Display information about this unit: <ul style="list-style-type: none"> • Unit model number • Serial number • Battery installation date • Suggested battery replacement date • Replacement Battery Cartridge model number • UPS firmware version

Advanced menus

The Advanced menus provide additional options for the UPS and are available only if the display interface is configured to use the Advanced menus.

Menu	General Functions
Status	View detailed information about the UPS: <ul style="list-style-type: none"> • Energy meter • Load current • Status of the Switched Outlet Group • Battery voltage
Configuration	Configure advanced settings for the UPS: <ul style="list-style-type: none"> • Main and Switched Outlet Group—delays and settings • High and lower transfer points • Sensitivity settings • Date of last battery replacement
Control	Control the Main and Switched Outlet Group to turn on, turn off, or reboot.
Test & Diags	Perform a UPS alarm test or a runtime calibration test.
Log	View the event log for information about any changes to the UPS and any faults.
About	View information about the unit: <ul style="list-style-type: none"> • Hardware version • Software version • NMC information (if applicable)

Configuration

UPS Settings

Start-up Settings

Configure these settings at initial start-up, using the display interface or APC PowerChute® software.



Note: During start-up, use the display interface to configure these settings. If nothing is selected, the unit will use the default settings.

Function	Factory Default	Options	Description
Language	English	<ul style="list-style-type: none">• English• French*• German*• Spanish*• Italian*	The language for the display interface. *Language options will vary by model.
Local Power Quality	Good	<ul style="list-style-type: none">• Good• Fair• Poor	Select the quality of input utility power. <ul style="list-style-type: none">• If Good is selected, the unit will go on battery power more often to provide the cleanest power supply to the connected equipment.• If Poor is selected, the UPS will tolerate more fluctuations in power and will go on battery power less often. If unsure of the local power quality, select Good.
Menu Type	Standard	Standard or Advanced	The advanced menus include all parameters. The Standard menus display a limited set of menus and options.
Display Mode	Always On	Always On or Power Saving	The display may be always on or may be set to automatically turn on only when using the configuration buttons or if an event occurs.

General Settings

Configure these settings at any time, using the display interface or APC PowerChute® software.

Function	Factory Default	Options	Description
High Transfer Point	120 V: 127 Vac	<ul style="list-style-type: none">• 127 Vac• 130 Vac• 133 Vac• 136 Vac	To avoid unnecessary battery usage, set the transfer point higher if the utility voltage is chronically high and the connected equipment is known to work under this condition. The POWER QUALITY setting will automatically change this setting.
	230 V: 253 Vac	<ul style="list-style-type: none">• 253 Vac• 257 Vac• 261 Vac• 265 Vac	Note: Use the Advanced Menus to configure this setting.

Function	Factory Default	Options	Description
Low Transfer Point	120 V: 106 Vac	<ul style="list-style-type: none"> • 97 Vac • 100 Vac • 103 Vac • 106 Vac 	Set the transfer point lower if the utility voltage is chronically low and the connected equipment can tolerate this condition. This setting may also be adjusted using the power quality setting. Note: Use the Advanced Menus to configure this setting.
	230 V: 208 Vac	<ul style="list-style-type: none"> • 196 Vac • 200 Vac • 204 Vac • 208 Vac 	
Nominal Output Voltage	120 Vac	N/A	Set the nominal output voltage of the UPS on battery. This is available on 230 V models only.
	230 Vac	208-252 Vac	
Transfer Sensitivity	High	High, Low, Medium	<p>Select the level of sensitivity to power events that the UPS will tolerate.</p> <ul style="list-style-type: none"> • High: The UPS will go on battery power more often to provide the cleanest power supply to the connected equipment. • Low: The UPS will tolerate more fluctuations in power and will go on battery power less often. <p>If the connected load is sensitive to power disturbances, set the sensitivity to High.</p>
Low Battery Warning	120 sec	Set the value in seconds	The UPS will emit an audible alarm when the remaining runtime has reached this level.
Date of Last Battery Replacement	Date set at factory	Reset this date when the battery module is replaced.	
Audible Alarm	On	On/Off	The UPS will mute all audible alarms if this is set to Off or when the display buttons are pressed.
Battery Self-Test Interval Setting	On start-up and every 14 days since the last test	<ul style="list-style-type: none"> • Never • Start-up only • Frequency of test (days) 	The interval at which the UPS will execute a self-test.
Reset to Factory Default	No	Yes/No	Restore the UPS factory default settings.

Main Outlet Group and the Switched Outlet Group

Overview

The Main Outlet Group and the Switched Outlet Group can be configured to independently turn off, turn on, shut down, and reboot connected equipment. (These features are not available on the 750 VA units.)

The Main Outlet Group and the Switched Outlet Group can be commanded to do the following:

- Turn off: Disconnect from power immediately and restart only with a manual command
- Turn on: Connect to power immediately
- Shutdown: Disconnect power in sequence, and automatically reapply power in sequence when utility power becomes available
- Reboot: Shut down and restart

In addition, the Main Outlet Group and the Switched Outlet Group can be configured to do the following:

- Turn on or off in a specified sequence
- Automatically turn off or shut down when various conditions occur



Note: If the Main Outlet Group and the Switched Outlet Group are not configured, all of the outlets on the unit will still provide battery back-up power.

Using the Main Outlet Group and the Switched Outlet Group



The Main Outlet Group functions as a master switch. It will turn on first when power is applied, and shut off last when there is a power outage and battery run-time has been exhausted.

The Main Outlet Group must be turned on for the Switched Outlet Group to turn on.

1. Connect critical equipment to the Main Outlet Group.
2. Connect peripheral equipment to the Switched Outlet Group.
 - Nonessential equipment that should shut off quickly in the event of a power outage to conserve battery runtime can be added to a short power-off delay
 - If equipment has dependent peripherals that must restart or shut down in a specific order, such as an ethernet switch that must restart before a connected server, connect the devices to separate groups
 - Equipment that needs to reboot independently from other equipment should be added to a separate group
3. Use the Configuration menus to configure how the Switched Outlet Group will react in the event of a power outage.

Customize the Main Outlet Group and the Switched Outlet Group

Use the **Control** menus to change the Switched Outlet Group and the Main Outlet Group settings.

Function	Factory Default	Options	Description
Name String Outlet Group	Outlet Group 1	Edit these names using an external interface, such as the Network Management Card Web interface.	
UPS Name String	UPS Outlets		
Turn On Delay	0 sec	Set the value in seconds	The amount of time the UPS or Switched Outlet Group will wait between receiving the command to turn on and the actual startup.
Turn Off Delay	0 sec	Set the value in seconds	The amount of time that the UPS or Switched Outlet Group will wait between receiving the command to turn off and the actual shut down.
Reboot Duration	4 sec	Set the value in seconds	The amount of time that the UPS or Switched Outlet Group must remain off before it will restart.
Minimum Return Time	0 sec	Set the value in seconds	The amount of battery runtime that must be available before the UPS or Switched Outlet Group will turn on.
Load Shed On Battery	Disabled	<ul style="list-style-type: none"> • Shutdown with Delay • Shutdown immediately • Turn off immediately • Turn off with delay • Disabled 	<p>When the unit switches to battery power, the UPS can disconnect power to the Switched Outlet Group to save runtime.</p> <p>Configure this delay time, use the LOAD SHED TIME WHEN ON BATTERY setting.</p>
Load Shed Time when On Battery	Disabled	Set the value in seconds	The amount of time the outlets will function on battery power before they will turn off.
Load Shed On Runtime	Disabled	<ul style="list-style-type: none"> • Shutdown with delay • Shutdown immediately • Turn off immediately • Turn off with delay • Disabled 	<p>When the battery runtime falls below the specified value, the Switched Outlet Group will turn off.</p> <p>Configure this time using the LOAD SHED RUNTIME REMAINING setting.</p>
Load Shed On Runtime Remaining	Disabled	Set the value in seconds	When the remaining runtime reaches this level, the Switched Outlet Group will turn off.
Load Shed on Overload	Disabled	<ul style="list-style-type: none"> • Disabled • Enabled 	In the event of an overload (greater than 100% output), the Switched Outlet Group will immediately turn off to conserve power for critical loads. The Switched Outlet Group will only turn on again with a manual command.

Network Management Card Settings

These settings are available only on units that have a Network Management Card (NMC) and are set in the factory. These settings can only be modified using an external interface, like the NMC web interface.

- NMC IP Address Mode
- NMC IP Address
- NMC Subnet Mask
- NMC Default Gateway

Emergency Power Off

EPO Overview

The Emergency Power Off (EPO) option is a safety feature that will immediately disconnect all connected equipment from utility power. The UPS will immediately shut down and will not switch to battery power.

The UPS must be manually re-started to re-apply power to connected equipment and to the UPS. Press ON/OFF on the front panel of the unit.

Normally open contacts

1. If the EPO switch or relay contacts are normally open, insert the wires from the switch or contacts at pins 1 and 2 of the EPO terminal block. Use 16-28 AWG wire.
2. Secure the wires by tightening the screws.

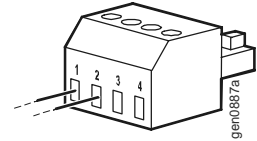

Power will be disconnected to the UPS and attached loads if the contacts are closed.

Normally closed contacts

1. If the EPO switch or relay contacts are normally closed, insert the wires from the switch or contacts at pins 2 and 3 of the EPO terminal block. Use 16-28 AWG wire.
2. Insert a wire jumper between pins 1 and 2. Secure the wires by tightening the three screws at position 1, 2, and 3.

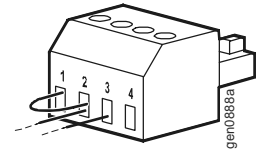

Power will be disconnected to the UPS and attached loads if the contacts are opened.

Note: The power for operating the EPO circuit is sourced from pin 1. This is an isolated 24 V which can source only a few milliamperes.

If the normally closed (NC) EPO configuration is used, the EPO switch or relay should be rated for "dry" circuit applications, the rating should be for low voltage and low current applications. This normally implies the contacts are gold-plated.

Adhere to all national and local electrical codes when wiring the EPO. Wiring must be performed by a qualified electrician.

The EPO interface is a Safety Extra Low Voltage (SELV) circuit. Connect the EPO interface only to other SELV circuits. The EPO interface monitors circuits that have no determined voltage potential. SELV circuits are controlled by a switch or relay properly isolated from utility power. To avoid damage to the UPS, do not connect the EPO interface to any circuit other than a SELV circuit.

Use one of the following cable types to connect the UPS to the EPO switch.

- CL2: Class 2 cable for general use.
- CL2P: Plenum cable for use in ducts, plenums, and other spaces used for environmental air.
- CL2R: Riser cable for use in a vertical run in a floor-to-floor shaft.
- CLEX: Limited use cable for use in dwellings and for use in raceways.
- Installation in Canada: Use only CSA certified, type ELC, (extra-low voltage control cable).
- Installation in countries other than Canada and the USA: Use standard low-voltage cable in accordance with national and local regulations.

Troubleshooting

Problem and Possible Cause	Solution
-----------------------------------	-----------------

The UPS will not turn on or there is no output

The unit has not been turned on.	Press the ON button once to turn on the UPS.
The UPS is not connected to utility power.	Ensure that the power cable is securely connected to the unit and to the utility power supply.
The input circuit breaker has tripped.	Reduce the load to the UPS, disconnect nonessential equipment and reset the circuit breaker.
The unit shows very low or no input utility voltage.	Check the AC power supply to the UPS by plugging in a table lamp. If the light is very dim, check the utility voltage.
The battery connector plug is not securely connected.	Ensure that all battery connections are secure.
There is an internal UPS fault.	Do not attempt to use the UPS. Unplug the UPS and have it serviced immediately.

The UPS is operating on battery, while connected to input utility power

The input circuit breaker has tripped.	Reduce the load to the UPS, disconnect nonessential equipment and reset the circuit breaker.
There is very high, very low, or distorted input line voltage.	Move the UPS to a different outlet on a different circuit. Test the input voltage with the utility voltage display. If acceptable to the connected equipment, reduce the UPS sensitivity.

UPS is emitting an audible beeping sound

The UPS is in normal operation.	None. The UPS is protecting the connected equipment.
---------------------------------	--

UPS does not provide expected backup time

The UPS battery is weak due to a recent outage or is near the end of its service life.	Charge the battery. Batteries require recharging after extended outages and wear out faster when put into service often or when operated at elevated temperatures. If the battery is near the end of its service life, consider replacing the battery even if the replace battery indicator is not yet illuminated.
The UPS is overloaded.	Check the UPS load display. Unplug unnecessary equipment, such as printers.

Display interface indicators flash sequentially

The UPS has been shut down remotely through software or an optional accessory card.	None. The UPS will restart automatically when utility power returns.
---	--

The Fault indicator is lit and the UPS displays a fault message and emits a constant beeping sound

Internal UPS fault.	Do not attempt to use the UPS. Turn the UPS off and have it serviced immediately.
---------------------	---

All indicators are illuminated and the UPS is plugged into a wall outlet

The UPS has shut down and the battery has discharged from an extended outage.	None. The UPS will return to normal operation when the power is restored and the battery has a sufficient charge.
---	---

Problem and Possible Cause	Solution
-----------------------------------	-----------------

The replace battery indicator is illuminated

The battery has a weak charge.

Allow the battery to recharge for at least four hours. Then, perform a self-test. If the problem persists after recharging, replace the battery.

The replacement battery is not properly connected.

Ensure that the battery connector is securely connected.

The display interface has a Site Wiring Fault message

Wiring faults detected include missing ground, hot-neutral, polarity reversal, and overloaded neutral circuit.

If the UPS indicates a site wiring fault, have a qualified electrician inspect the building wiring. (Applicable for 120 V units only.)

Service and Support

Service

If the unit requires service, do not return it to the dealer. Follow these steps:

1. Review the *Troubleshooting* section of the UPS manual to eliminate common problems.
2. If the problem persists, contact APC Customer Support through the APC Web site, **www.apc.com**.
 - a. Note the model number and serial number, located on the rear of the unit, and the date of purchase.
 - b. Call APC Customer Support and a technician will attempt to solve the problem over the phone. If this is not possible, the technician will issue a Returned Material Authorization Number (RMA#).
 - c. If the unit is under warranty, the repairs are free.
 - d. Service procedures and returns may vary internationally. Refer to the APC Web site for country specific instructions.
3. Pack the unit in its original packaging. If this is not available, refer to **www.apc.com** to obtain a new set.
 - a. Pack the unit properly to avoid damage in transit. Never use foam beads for packaging. Damage sustained in transit is not covered under warranty.
 - b. **For the UPS, always DISCONNECT THE BATTERY before shipping in compliance with U.S. Department of Transportation (DOT) and IATA regulations.** The battery may remain in the unit.
 - c. Internal batteries may remain connected in the XLBP during shipment (if applicable, not all units have XLBPs).
4. Write the RMA# provided by Customer Support on the outside of the package.
5. Return the unit by insured, pre-paid carrier to the address provided by Customer Support.

Transport the unit

1. Shut down and disconnect all connected equipment.
2. Disconnect the unit from utility power.
3. Disconnect all internal and external batteries (if applicable).
4. Follow the shipping instructions outlined in the *Service*.

APC Worldwide Customer Support

Customer support for this or any other APC product is available at no charge in any of the following ways:

- Visit the APC Web site to access documents in the APC Knowledge Base and to submit customer support requests.
 - **www.apc.com** (Corporate Headquarters)
Connect to localized APC Web sites for specific countries, each of which provides customer support information.
 - **www.apc.com/support/**
Global support searching APC Knowledge Base and using e-support.
- Contact the APC Customer Support Center by telephone or e-mail.
 - Local, country-specific centers: go to **www.apc.com/support/contact** for contact information.

For information on how to obtain local customer support, contact the APC representative or other distributors from whom you purchased your APC product.

Smart-UPS Factory Warranty

LIMITED WARRANTY

American Power Conversion (APC) warrants its Smart-UPS (Products) to be free from defects in materials and workmanship for a period of three (3) years, excluding the batteries, which are warranted for two (2) years from date of purchase. APC's obligation under this warranty is limited to repairing or replacing, at its own sole option, any such defective products. Repair or replacement of a defective Product or part thereof does not extend the original warranty period.

This warranty applies only to the original purchaser who must have properly registered the Product within 10 days of purchase. Products may be registered online at warranty.apc.com.

APC shall not be liable under this warranty if its testing and examination disclose that the alleged defect in the Product does not exist or that it was caused by end user's or any third person's misuse, negligence, improper installation, testing, operation or use of the Product contrary to APC's recommendations or specifications. Further, APC shall not be liable for defects resulting from: 1) unauthorized attempts to repair or modify the Product, 2) incorrect or inadequate electrical voltage or connection, 3) inappropriate on-site operation conditions, 4) Acts of God, 5) exposure to the elements, or 6) theft. In no event shall APC have any liability under this warranty for any Product where the serial number has been altered, defaced, or removed.

EXCEPT AS SET FORTH ABOVE, THERE ARE NO WARRANTIES, EXPRESS OR IMPLIED, BY OPERATION OF LAW OR OTHERWISE, APPLICABLE TO PRODUCTS SOLD, SERVICED OR FURNISHED UNDER THIS AGREEMENT OR IN CONNECTION HEREWITH.

APC DISCLAIMS ALL IMPLIED WARRANTIES OF MERCHANTABILITY, SATISFACTION AND FITNESS FOR A PARTICULAR PURPOSE.

APC EXPRESS WARRANTIES WILL NOT BE ENLARGED, DIMINISHED, OR AFFECTED BY AND NO OBLIGATION OR LIABILITY WILL ARISE OUT OF, APC'S RENDERING OF TECHNICAL OR OTHER ADVICE OR SERVICE IN CONNECTION WITH THE PRODUCTS.

THE FOREGOING WARRANTIES AND REMEDIES ARE EXCLUSIVE AND IN LIEU OF ALL OTHER WARRANTIES AND REMEDIES. THE WARRANTIES SET FORTH ABOVE CONSTITUTE APC'S SOLE LIABILITY AND PURCHASER'S EXCLUSIVE REMEDY FOR ANY BREACH OF SUCH WARRANTIES. APC'S WARRANTIES RUN ONLY TO ORIGINAL PURCHASER AND ARE NOT EXTENDED TO ANY THIRD PARTIES.

IN NO EVENT SHALL APC, ITS OFFICERS, DIRECTORS, AFFILIATES OR EMPLOYEES BE LIABLE FOR ANY FORM OF INDIRECT, SPECIAL, CONSEQUENTIAL OR PUNITIVE DAMAGES, ARISING OUT OF THE USE, SERVICE OR INSTALLATION, OF THE PRODUCTS, WHETHER SUCH DAMAGES ARISE IN CONTRACT OR TORT, IRRESPECTIVE OF FAULT, NEGLIGENCE OR STRICT LIABILITY OR WHETHER APC HAS BEEN ADVISED IN ADVANCE OF THE POSSIBILITY OF SUCH DAMAGES. SPECIFICALLY, APC IS NOT LIABLE FOR ANY COSTS, SUCH AS LOST PROFITS OR REVENUE (WHETHER DIRECT OR INDIRECT), LOSS OF EQUIPMENT, LOSS OF USE OF EQUIPMENT, LOSS OF SOFTWARE, LOSS OF DATA, COSTS OF SUBSTITUANTS, CLAIMS BY THIRD PARTIES, OR OTHERWISE.

NO SALESMAN, EMPLOYEE OR AGENT OF APC IS AUTHORIZED TO ADD TO OR VARY THE TERMS OF THIS WARRANTY.

NOTHING IN THIS LIMITED WARRANTY SHALL SEEK TO EXCLUDE OR LIMIT APC'S LIABILITY FOR DEATH OR PERSONAL INJURY RESULTING FROM ITS NEGLIGENCE OR ITS FRAUDULENT MISREPRESENTATION OR TO THE EXTENT THAT IT CANNOT BE EXCLUDED OR LIMITED BY APPLICABLE LAW.

To obtain service under warranty you must obtain a Returned Material Authorization (RMA) number from customer support. Customers with warranty claims issues may access the APC worldwide customer support network through the APC Web site: support.apc.com. Select your country from the country selection pull-down menu. Open the Support tab at the top of the web page to obtain contact information for customer support in your region. Products must be returned with transportation charges prepaid and must be accompanied by a brief description of the problem encountered and proof of date and place of purchase.



EC Declaration of Conformity

2009
Date of product declaration

Harmonized Standards	EN62040-1-1, EN62040-2, EN60950-1, IEC60950-1, EN55022, EN55024, IEC61000-3-2, 3-3, 4-2, 4-3, 4-4, 4-5, 4-6, 4-11	
Applicable Council Directives	2006/95/EC; 2004/108/EC	
Type of Equipment	Uninterruptible Power Supply	
Model Numbers	SMT750I, SMT1000I, SMT1500I, SMT2200I, SMT3000I	
Manufacturers		
American Power Conversion 132 Fairgrounds Rd West Kingston, RI 02892 USA	American Power Conversion 2nd Street, PEZA Cavite Economic Zone Rosario, Cavite Philippines	APC (Suzhou) UPS Co., Ltd 339 Suhong Zhong Lu Suzhou Industrial Park Suzhou Jiangsu 215021 P.R. China
American Power Conversion Ballybritt Business Park Galway Ireland	American Power Conversion Lot 10, Block 16, Phase 4 PEZA, Rosario, Cavite Philippines	APC Power Infrastructure Co., Ltd 1678 Ji Xian Road, Tong An Xiamen 361100 P.R. China
American Power Conversion Breaffy Rd, Castlebar Co Mayo Ireland	American Power Conversion Lot 3, Block 14, Phase 3 PEZA, Rosario, Cavite Philippines	APC India Pvt Ltd 187/3, Jigani Industrial Area Bangalore, Karnataka 562106 India
		APC Brazil LTDA Al. Xingu, 850, Barueri Alphaville/Sao Paulo 06455-030 Brazil
Importer	American Power Conversion (APC) Ballybritt Business Park Galway, Ireland	
Place	Galway, Ireland	Gerry Daly, Managing Director, Europe 01/February/2009

© 2009 APC by Schneider Electric. APC, the APC logo are owned by Schneider Electric Industries S.A.S., American Power Conversion Corporation, or their affiliated companies. All other trademarks are property of their respective owners.